

---

**Technical Service Manual**

---

**Panther 306  
Electronic Key Telephone System**

---

**TRILLIUM Telephone Systems**

---

Electronics Division Telephones 306/612

The PANTHER 306 Key Telephone System is a PANTHER 612 System which has been slightly downsized to better accommodate smaller business. For your convenience, the table below highlights major differences between the two systems. Refer to the reverse of this Update Sheet for Technical Specifications.



ITEM	306	612
CO Lines	3-	6
Stations	6	12
Attendants (BLF Sets)	6 max	6 max
Key Service Unit Types	Tone/Rot Only	Tone or Tone/Rot
Set Types	3 Line/6 DSS - NHF 3 Line/6 DSS - HF/BLF	6 Line/12 DSS - NHF 6 Line/12 DSS - HF/BLF
<b>FEATURES</b> External Page Loud Bell	No No	Yes Yes
<b>OPTIONS</b> SMDR	No	Yes

NOTE: ICM = Intercom, NHF = Non-Handsfree, BLF = Busy Lamp Field, HF = Handsfree  
Tone/Rot = Tone/Rotary

## System Capabilities

---

Outside Lines	3 (2 with Door Answer)
PANTHER Sets	6
Intercom Speech Paths	3
Attendant Sets	6 max
Door Modules	2
Power Fail Transfer	1 Unit transfers 3 outside lines to 3 standard phones

## Power

---

AC Power Requirements	110 Volts $\pm$ 10% (50/60 Hz) 1 Amp max load
Station Loop Limit	240 ohms max (Equivalent to 2000 feet 24 AWG)

## Environmental

---

Operating Temperature	32°F to 104°F (0°C to 40°C)
Relative Humidity	90% or less, non-condensing
Signaling	Rotary Dial and/or Tone Dial

## Number Plan

---

Station Numbers	10 to 15
-----------------	----------

## Connectors

---

KSU Line Connectors	Lines 1 and 2, and 3 - 4-conductor modular
KSU Set Connector	Sets 10 to 15 - 50-pin connector
KSU External Battery Connectors	Clips
KSU Door Answer Unit Connector	6-conductor modular
KSU Power Fail Transfer Connector	4-conductor modular
KSU Music Input	Mono 1/8 inch Mini Jack
Set Connector	6-conductor modular - pins 2, 3, 4, 5 interface to the Voice and Data Pairs; - pins 1 and 6 provide an interface for connecting an external amplifier to the speaker terminals



*Specifications and features are subject to change without notice.*

---

### U.S. Marketing Headquarters/U.S. Operations

Trillium Telephone Systems Corporation  
1675 MacArthur Blvd.,  
Costa Mesa, California 92626, Tel.: (714) 557-3300

### Canadian Sales

Trillium Telephone Sales Inc.  
155 Gordon Baker Road, Suite 206, Willowdale,  
Ontario, M2H 3N5 Tel.: (416) 494-0522

### International Sales

Trillium Telephone Systems Inc.  
603 March Road, P.O. Box 13030, Kanata, Ontario, K2K 1X3  
Telex: 053-4524, Tel.: (613) 592-2550, Fax: (613) 592-2555

© Copyright 1987 TRILLIUM Telephone Systems Inc.  
™ Trademark of TRILLIUM Telephone Systems Inc.  
91-0362-2A - March 1987 - Printed in Japan  
F-3015-1

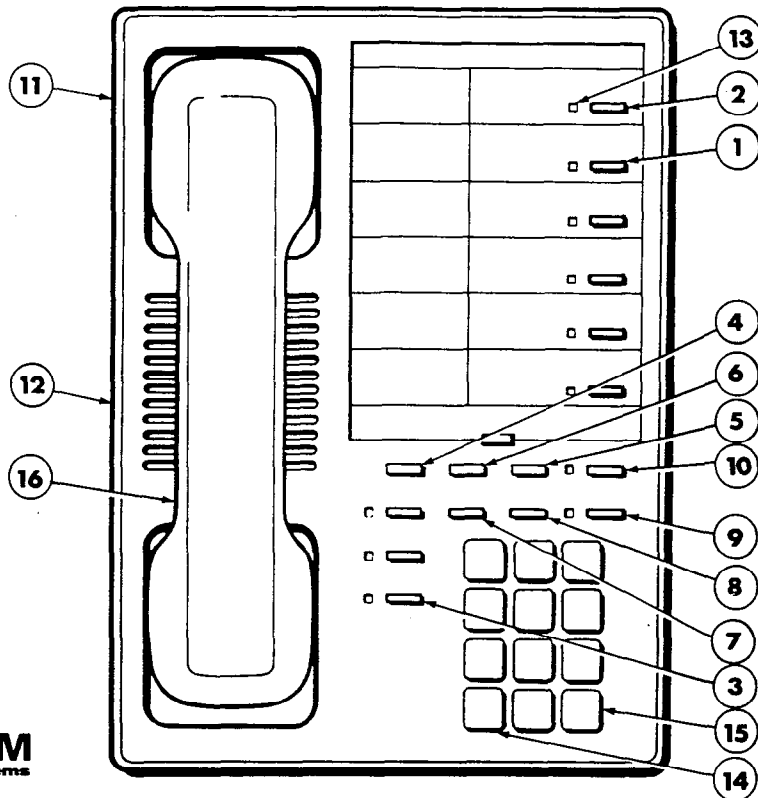

- 1 **Station Select/Speed Call** - dual-function keys used to make intercom paging announcements and to dial private speed call numbers.
- 2 **Redial** - used to redial the last number manually dialed from your Set.
- 3 **Line** - used to select any of the outside lines (unless programmed otherwise).
- 4 **Hold** - places outside calls on hold and exclusive hold.
- 5 **Conference** - for setting up three-party add-on conference calls.
- 6 **Flash/Cancel** - programmable as a calibrated hookswitch flash or cancel, but not both:  
*Flash* provides a calibrated on-hook signal which is required to access most PBX, Centrex and network features.  
*Cancel* is used to cancel external calls and return dial tone without hanging up the handset.
- 7 **Speed** - used to enter private and common speed call numbers into the system's memory; also for dialing speed call numbers.
- 8 **Speaker** - turns the Set's speaker on and off; also used to end a handsfree call.
- 9 **Mic On/Off** - turns the Set's microphone on and off for handsfree calls.
- 10 **Intercom** - used to perform internal call transfers, activate paging, background music and various other features.
- 11 **Ringer Volume Control** - controls the volume of the tone ringing.
- 12 **Speaker Volume Control** - controls the volume of the speaker audio.
- 13 **Station Indicator Lamps** - (Panther 306 Attendant Set only) - turn on when the corresponding Set is busy on a call.
- 14 **Asterisk (\*)** - when the \* is dialed as the first digit in a telephone number sequence the last outside line used at your Set is automatically selected. (The handset must be in the cradle).
- 15 **Pound (#)** - when the # is dialed, the internal intercom line will be automatically selected, provided the handset is in the cradle and all speech paths are not in use.
- 16 **Handset** - used to place calls in the conventional handset manner. Provides more privacy than the handsfree method.

To use most of the PANTHER 306 system features, follow the PANTHER 612 operating instructions given in the PANTHER User Guide and the PANTHER Quick Reference Guide. PANTHER 306 system features which operate differently are described below.

### Private Speed Call - Dialing

#### To speed call one of your first 5 Private numbers -

- Lift the handset. Press the Line key of an outside line.  
*Handsfree* - Turn the Mic. on/off indicator on.  
*Handsfree* - Press the Line key of an outside line or press \* .  
Dial tone is heard; line indicator winks.
- Press desired Speed Call key (DSS keys 11-15).  
The number is automatically speed dialed.

OR

#### To speed call one of your last 6 Private Speed numbers -

- Lift the handset. Press the Line key of an outside line.  
*Handsfree* - Turn the Mic. on/off indicator on.  
*Handsfree* - Press the Line key of an outside line or press \* .  
Dial tone is heard; line indicator winks.
- Press the Speed key.
- Dial the desired Speed Call Code (from 05 to 10).  
The number is automatically speed dialed.

### Private Speed Call - Storing

#### To store your first 5 Private Speed Call entries -

- Press the Speed key.  
Continuous tone is heard; intercom indicator winks.
- Press the desired Speed Call key (11-15).  
Intercom indicator flashes.
- Dial the entry to be stored including any pauses, halts, flashes.  
Maximum 26 digits.  
Continuous tone stops; indicator continues to flash.
- Write the entry on the designation card.
- Repeat above procedure for each entry to be stored.

#### To store your last 6 Private Speed Call entries -

- Press the Speed key.  
Continuous tone is heard; intercom indicator winks.
- Dial the desired speed call code (05 to 10).  
Intercom indicator flashes.
- Dial the entry to be stored including any pauses, halts, flashes.  
Maximum 26 digits.  
Continuous tone stops; indicator continues to flash.
- Write the entry on the designation card.
- Repeat above procedure for each entry to be stored.

### Door Answering

Line key 3 is used to access the Door Module.

#### To answer a door call (from either Module) -

- Distinctive tone ringing is heard. Line 3 indicator flashes.
- Lift the handset; press Line key 3.  
*Handsfree* - Turn the Mic. on/off indicator on; press Line key 3.  
Line 3 indicator winks.  
The visitor at the door need only speak in the direction of the Door Module.

#### To place an intercom call to Door Module One -

- Lift the handset; press Line key 3.  
*Handsfree* - Turn the Mic. on/off indicator on; press Line key 3.  
One ringing burst is heard; line 3 indicator winks.
- Make your announcement.  
The called party answers by speaking in the direction of the Door Module.

#### To end a Door Module conversation -

- Hang up the handset.  
*Handsfree* - Press the Speaker key.  
Line 3 indicator turns off.

### Features that do not apply to the PANTHER 306 System:

Music through external paging system  
Non-appearing line access  
Call Data Recording operations

Call the attendant by dialing 0  
Message waiting from the attendant  
Loudspeaker Paging



Specifications and features are subject to change without notice.

#### U.S. Marketing Headquarters/U.S. Operations

Trillium Telephone Systems Corporation  
1675 MacArthur Blvd.,  
Costa Mesa, California 92626, Tel.: (714) 557-3300

#### Canadian Sales

Trillium Telephone Sales Inc.  
155 Gordon Baker Road, Suite 206, Willowdale,  
Ontario, M2H 3N5 Tel.: (416) 494-0522

#### International Sales

Trillium Telephone Systems Inc.  
603 March Road, P.O. Box 13030, Kanata, Ontario, K2K 1X3  
Telex: 053-4524, Tel.: (613) 592-2550, Fax: (613) 592-2555

© Copyright 1987 TRILLIUM Telephone Systems Inc.  
™ Trademark of TRILLIUM Telephone Systems Inc.  
91-0363-2A - March 1987 - Printed in Japan  
F-3014-1

# Panther™ 306

## Electronic Key Telephone System

Due to the similarity between the PANTHER 306 and PANTHER 612 systems, MOST of the installation and programming instructions found on the **PANTHER 612 Electronic Key System Installation Guide** will apply to both systems. This Update Sheet outlines all differences which must be taken into consideration when installing and programming the PANTHER 306 System ONLY. When following this update refer to the **PANTHER 612 Electronic Key System Installation Guide** included with your system.

Side One of the **PANTHER 612 Electronic Key System Installation Guide** provides a detailed illustration plus step-by-step instructions for mounting and connecting PANTHER 612 components. Some of these components will not be used when connecting only the PANTHER 306 System. Component differences are shown below. Refer to the reverse of this Update Sheet, for changes to installation and programming.

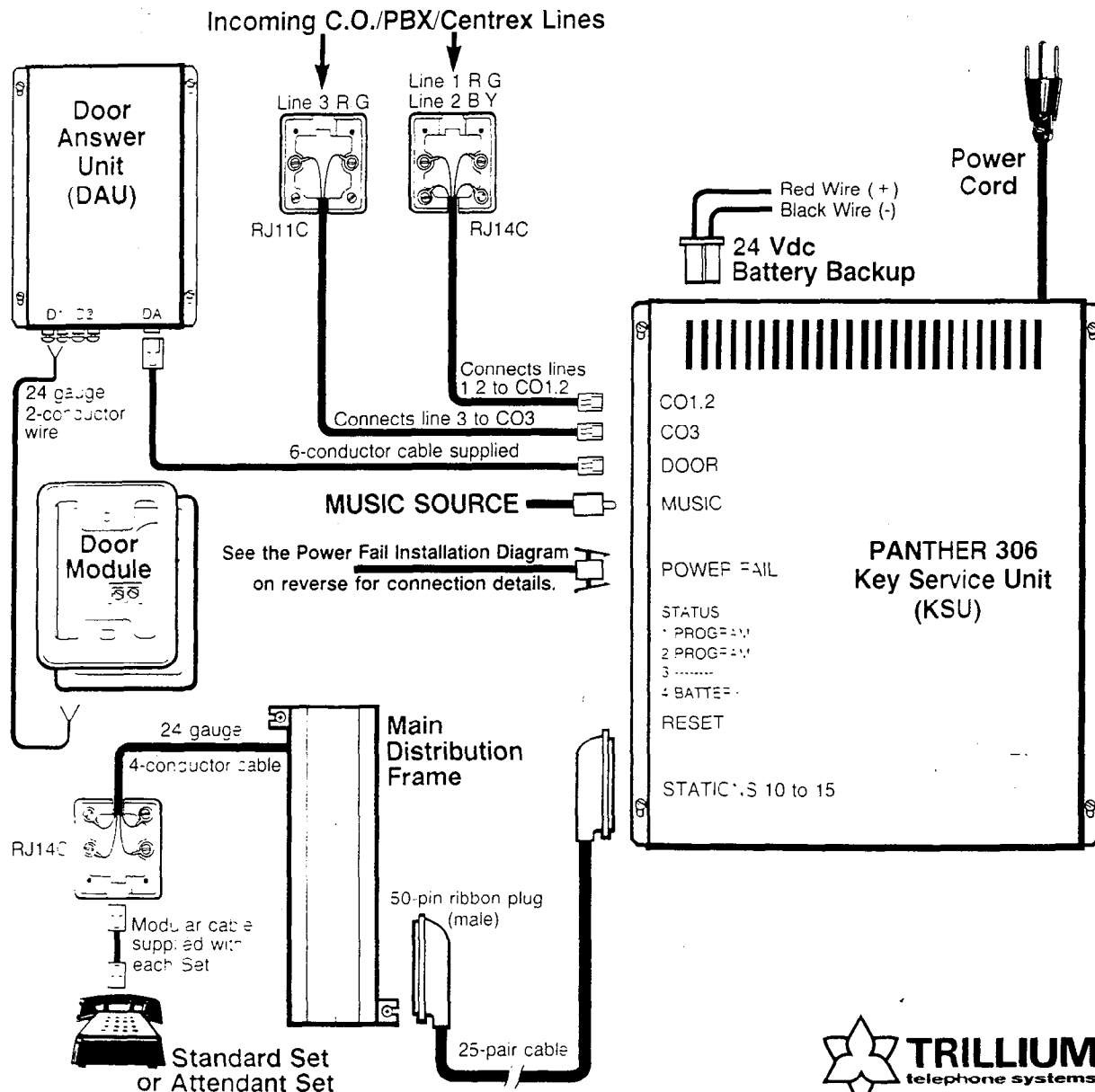

## INSTALLATION PROCEDURE CHANGES -

(Refer to the PANTHER 612 Electronic Key System Installation Guide, Side One)

### STEP 2 - Telephone Line Connection

Do not connect telephone line 3 when the Door Answering Option is being installed.

### STEP 3 - KSU to 66-Block Connections

The KSU connector is labelled "Stations 10-15".

### STEP 5 - Station Wiring Connections

Ignore Station Numbers 16 to 21 and DRY CONTACTS wiring on the Station Wiring Chart.

### STEP 6 - Door Answering

The Door Answering Option uses C.O. line 3. Ensure that telephone line 3 is not connected to the KSU.

**STEP 7 - Call Data Recording Interface - Not Equipped**  
Ignore this step.

### STEP 9 - Power Fail Transfer

Only one PFT unit is connected to the PANTHER 306 System. Correct installation is shown below.

**STEP 11 - External Paging Amplifier - Not Equipped.** Ignore this step.

Side Two of the PANTHER 612 Electronic Key System Installation Guide contains the necessary information for selecting and programming system features, as well as information on troubleshooting. The following changes apply when programming the PANTHER 306 System:

- When programming Code 0000, ignore lit Line 3 LED and lit Intercom LED. (No LOUD BELL feature exists.)
- When programming Code 3YY1 (ZONE PAGING), disregard all zone information after Zone 6.
- When programming Code 5XX0, ignore all LOUD BELL PAGING information.
- When programming, ignore all of Code 0061. (CDR Start Date Recording does not apply.)
- When programming RINGING ASSIGNMENT, ignore lit Intercom LED for Code 2YY0 (No Line 4), and ignore all of Code 2YY1.
- When programming LINE GROUPING, ignore lit Intercom LED for Code 6ZZ0 (No Line 4), and ignore all of Code 6ZZ1.

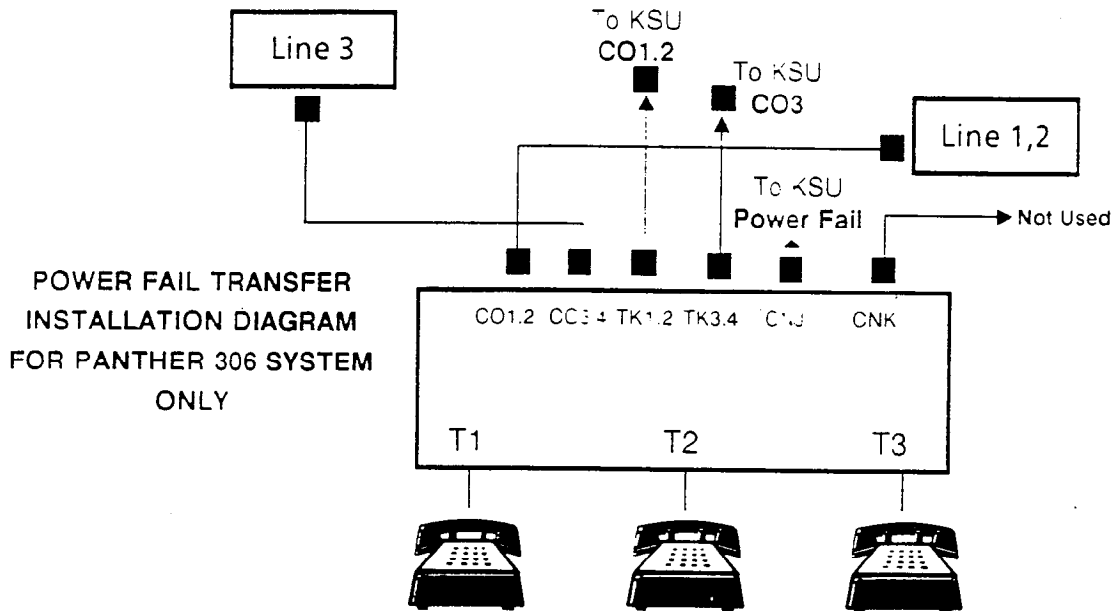

Specifications and features are subject to change without notice.

**U.S. Marketing Headquarters/U.S. Operations**  
Trillium Telephone Systems Corporation  
1675 MacArthur Blvd.,  
Costa Mesa, California 92626 Tel.: (714) 557-3300

**Canadian Sales**  
Trillium Telephone Systems Inc.  
155 Gordon Baker Road, Suite 206, Willowdale  
Ontario, M2H 3N5 Tel.: (416) 494-0522

**International Sales**  
Trillium Telephone Systems Inc.  
603 March Road, P.O. Box 13030, Kanata, Ontario, K2K 1X3  
Tel.: (613) 592-2554, Tel.: (613) 592-2555, Fax: (613) 592-2555

© Copyright 1987 TRILLIUM Telephone Systems Inc.  
™ Trademark of TRILLIUM Telephone Systems Inc.  
91-3364-1A - March 1987 - Printed in Canada

---

# Technical Service Manual

---

## Panther 306/Panther 612 Electronic Key Telephone Systems

### NOTE

When the organization for this manual was first conceived, most chapters were designed to include more than one system — since a large number of functions, features, and characteristics are common to TRILLIUM's telephone systems.

For example, the Panther 306 and 612 Electronic Key Telephone Systems are very similar; coverage of these two systems was to have been combined into a single chapter — as evidenced by the single Panther 306/612 tab.

However, interrupting the flow of text and graphics to identify and explain the differences between these systems proved to be too disruptive — and the potential for reader confusion began to outweigh the benefits of shared coverage.

In the end, giving each separate system its own chapter was judged to be much more useful to field installers and technicians (this manual's primary audience) in their normal work environment, under their normal operating circumstances.

Therefore, the Panther 306 system — and only the Panther 306 system — is the subject of the first chapter under this tab (starting at the first red page), followed by the separate Panther 612 chapter (starting at the second red page).



*Topic*

*Page*

**Chapter Introduction**

PREFACE ..... Intro-1  
ABOUT THIS CHAPTER ..... Intro-1  
QUICK-REFERENCE CHART ..... Intro-2

**Section A — FCC Requirements**

RADIO AND TELEVISION INTERFERENCE ..... A-1  
HEARING AID COMPATIBILITY ..... A-1  
RESPONSIBILITIES ..... A-2  
    User Responsibilities ..... A-2  
    Telco Responsibilities ..... A-2

**Section B — System Components**

STANDARD COMPONENTS ..... B-1  
    One Key Service Unit (KSU) ..... B-1  
    Up to Six Telephone Sets ..... B-1  
OPTIONAL COMPONENTS ..... B-2  
    One Door Answer Unit ..... B-2  
    One Power Fail Transfer Unit ..... B-2  
    Up to Five Off Premises Extension/Data Interface (OPX) units ..... B-2  
    Set Stands/Wall-Mounts ..... B-2  
    Designation Cards ..... B-3  
    Face Plates ..... B-3

**Section C — Technical Specifications**

CONNECTORS ..... C-1  
ENVIRONMENTAL REQUIREMENTS ..... C-1  
POWER REQUIREMENTS ..... C-1  
STATION NUMBERING PLAN ..... C-1  
SYSTEM CAPABILITIES ..... C-1

*Topic* *Page*

## Section D — Connection Procedures

STEP 1: INSTALLING THE KSU.....	D-1
Site Preparation.....	D-1
Backboard Installation.....	D-1
System Uncrating.....	D-1
KSU Installation.....	D-1
STEP 2: CONNECTING INCOMING TELEPHONE LINES.....	D-2
STEP 3: INSTALLING STATION WIRING.....	D-2
Station Wiring Table.....	D-3
STEP 4: CONDUCTING THE INITIAL SYSTEM AND STATION TESTS.....	D-4
STEP 5: CONNECTING THE BACKUP BATTERY.....	D-4
STEP 6: CONNECTING DOOR ANSWER UNIT AND DOOR MODULES.....	D-4
Door Answer Unit Installation.....	D-4
Door Module Installation.....	D-5
Door Answer Unit Test.....	D-5
STEP 7: CONNECTING THE MUSIC SOURCE.....	D-6
Music Connection.....	D-6
Music Test.....	D-6
STEP 8: CONNECTING THE OPX UNIT.....	D-7
OPX Unit Connection.....	D-7
OPX Unit Test.....	D-7
STEP 9: CONNECTING THE POWER FAIL TRANSFER UNIT.....	D-8
Power Fail Transfer Unit Installation.....	D-8
Power Fail Transfer Unit Test.....	D-8
STEP 10: INSTALLING AN EXTERNAL AMPLIFIER/SPEAKER.....	D-9

## Section E — System and Set Layout

TYPICAL SYSTEM LAYOUT DIAGRAM (Standard Components only).....	E-1
TYPICAL SYSTEM LAYOUT DIAGRAM (Optional and External Components only).....	E-2
TYPICAL POWER FAIL TRANSFER UNIT LAYOUT DIAGRAM.....	E-3
SET LAYOUT DIAGRAM.....	E-4
SET LAYOUT.....	E-5

*Topic*

*Page*

**Section F — Feature Programming**

FEATURE CATEGORIES.....	F-1
Categories Versus Codes.....	F-1
Referencing Categories to Codes.....	F-1
Interrelated Features.....	F-1
Feature Programming Cross-Reference Table.....	F-2
SYSTEM-WIDE FEATURES.....	F-4
System-Wide Feature Programming Table.....	F-5
INDIVIDUAL SET FEATURES.....	F-8
Individual Set Feature Programming Table.....	F-9
INDIVIDUAL LINE FEATURES.....	F-10
Individual Line Feature Programming Table.....	F-11
INDIVIDUAL GROUP FEATURES.....	F-12
Individual Group Feature Programming Table.....	F-13
SPEED CALL NUMBERS.....	F-14
Speed Call Programming Notes.....	F-14
Common Speed Call Numbers.....	F-14
Private Speed Call Numbers.....	F-15
FEATURE DESCRIPTIONS.....	F-15

**Section G — Operating Instructions**

OPERATING INSTRUCTIONS TABLE.....	G-1
-----------------------------------	-----

**Section H — Troubleshooting**

TROUBLESHOOTING TABLE.....	H-1
----------------------------	-----

## PREFACE

The Panther 306 Electronic Key Telephone System is a state-of-the-art system that incorporates sophisticated electronics to meet the communications needs of today's home, office, and small business user.

It connects three outside tone or rotary telephone lines (only two if the optional Door Answer Unit and Door Modules are installed) with up to six station Sets — which are all wired in a star configuration. Both Handsfree and Non-Handsfree Sets are available; the Handsfree Sets also include Busy Lamp Field (BLF) indicators that show the status of all system stations.

Common and private speed call numbers, call transferring, door answering (with optional Door Answer Unit and Door Modules), internal monitoring, conferencing (up to 3 parties), internal intercom paging (station-to-station, zone, and all page paging), and last number redialing are just some of the many features offered.

The attractive, well-designed system makes feature programming and operation very easy. In addition, the Panther system is designed to allow easy interfacing with modems and answering devices through an optional OPX device.

The fully sealed Panther 306 Electronic Key Telephone System may be installed in either a standalone mode or behind a CENTREX or PBX. The microprocessor-controlled circuitry operates all system communications and the flexible programming.

An optional external backup 24 V battery can be connected to the system; the backup battery is automatically brought on line in the event of a power failure, thus preventing interruptions in telephone service.

Also, in the event of a total system failure, incoming lines will be transferred to standard sets if the optional Power Transfer Unit has been installed in the system.

## ABOUT THIS CHAPTER

This chapter has also been designed specifically to enable technicians to install, operate, and maintain the Panther 306 Electronic Key Telephone System. Information is presented in a logical order, without undue wordiness — to help the technician find, understand, and use the relevant information, quickly and easily.

Therefore, for example, the Connection Procedures are separated into concise steps that have a logical and necessary sequence; and reference material (Technical Specifications, Feature Programming, Operating Instructions, and Troubleshooting) is presented in a variety of easy-to-follow, visible-at-a-glance tabular formats.

To acquaint yourself with this chapter, please review the Table of Contents and spend a few moments browsing through the different sections.

## CAUTION

Panther equipment is sealed. Breaking the seal will void your warranty.



If you have an installation, operation, or troubleshooting problem that you cannot solve by using this chapter (and that your dealer cannot help solve), call TRILLIUM Customer Service at 1-800-848-2444 (inside California, call 1-800-422-7600).

## NOTE

For your ready reference, a chart summarizing indicator signals appears on the back of this page.

## QUICK-REFERENCE CHART

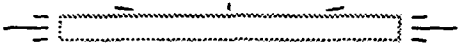
The Panther 306 Electronic Key Telephone System lets users know what is happening with calls and lines through a series of indicator patterns. These indications are summarized in the chart on this page. Specific indications are described at the appropriate places throughout the procedural material in this chapter.

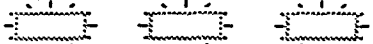
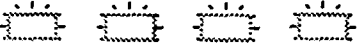
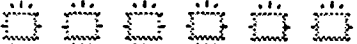
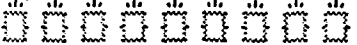
Line Indicator Action	Line Status
<p>OFF</p> 	Line idle
<p>ON</p> 	Line in use or on exclusive hold at another station
<p>Slow WINKING</p> 	Line in use at your Set
<p>Very slow FLASHING</p> 	Line on hold at another station
<p>Slow FLASHING</p> 	Incoming call
<p>Quick FLASHING</p> 	Line on hold at your Set
<p>Very quick FLASHING</p> 	Line on exclusive hold at your Set

**RADIO AND TELEVISION  
INTERFERENCE**

**WARNING**

The Panther 306 Electronic Key Telephone System generates and uses radio-frequency energy and — if not installed and used in strict accordance with these instructions — may cause interference to radio and television reception.

The Panther 306 Electronic Key Telephone System has been certified to comply with the limits for a Class B computing device, pursuant to Subpart J of Part 15 of the Federal Communications Commission (FCC) Rules which are designed to provide reasonable protection from radio and television interference in a residential installation. However there is no guarantee that interference will not occur in a particular installation.

If interference is encountered, test to determine if the unit is at fault by unplugging the Key Service Unit (KSU) from the wall outlet.

If unplugging the KSU removes the interference, try the following corrective measures, singly or in combination, until the interference is eliminated:

- Change the location or position of the indoor receiving antenna of the radio or television.
- Relocate the Panther 306 Set or KSU in relation to the radio and television receivers experiencing interference.
- Plug the KSU into an outlet that does not also serve radio or television sets.

If further help is needed, consult your TRILLIUM dealer or an experienced radio/television technician — or refer to the FCC's booklet, "How to Identify and Resolve Radio-TV Interference Problems." It is available from the US Government Printing Office, Washington, DC 20402 (stock number 004-000-00345-4).

**HEARING AID COMPATIBILITY**

The Panther 306 Set is compatible for those requiring a hearing aid as defined in section 68.316, Part 68 of FCC Rules.

### RESPONSIBILITIES

The FCC's rules permit the Panther 306 Electronic Key Telephone System to be connected to the telephone network via a jack or jacks provided by the telephone company (telco). These jacks are not provided for coin or party lines.

#### User Responsibilities

Before connecting your Panther 306 Electronic Key Telephone System to the telephone lines, you must contact the telephone company and provide them with the following information:

- Telephone numbers of the lines to which the Panther 306 Electronic Key Telephone System is to be connected (lines 1, 2, and 3)
- FCC Registration Number (found on the side of the Key Service Unit or KSU: the number for the Panther 306 Electronic Key Telephone System is **EBS78T-71737-KF-E**)
- Ringer Equivalence Number (also found on the side of the KSU: the number for the Panther 306 Electronic Key Telephone System is 3.3B)\*
- USOC jacks required (usually one 4-conductor, RJ14 modular jack for lines 1 and 2; and one 2-conductor RJ11 jack for line 3)

You also have the responsibility to disconnect a malfunctioning Panther 306 Electronic Key Telephone System from the telephone lines until the cause of the malfunctioning is identified and repaired. Otherwise, the telephone company may temporarily disconnect service.

\* The Canadian Department of Communications load number for the Panther 306 Electronic Key Telephone System is 16B.

### Telco Responsibilities

The telephone company is required to give you adequate notice of any changes it makes in its technical operations or procedures that may affect the compatibility or use of your Panther 306 Electronic Key Telephone System.

## STANDARD COMPONENTS

### One Key Service Unit (KSU) Part Number 90-0290 (tone/rotary)

The key service unit (KSU) for the Panther 306 Electronic Key Telephone System can be programmed to operate with either dual-tone, multi-frequency (DTMF) or rotary (pulse) signaling. The signaling on each Central Office (CO) line can be programmed independently. The KSU has two connectors on its left side to attach the three incoming telephone company (telco) CO lines — one connector for lines 1 and 2; and a second connector for line 3 (which must be left vacant if the optional Door Answer Unit is installed).

Also on the left side of the KSU are connectors labeled DOOR (for the optional Door Answer Unit), MUSIC (for an external music source), POWER FAIL (for the optional Power Fail Transfer Unit).

Below these connectors, the KSU has one recessed light-emitting diode (LED) indicator (labeled STATUS), four miniature dual in-line package (DIP) switches (labeled, from top to bottom, 1 PROGRAM [used to return features to their default, factory preprogrammed conditions], 2 PROGRAM [used to program system features], 3 [not used], and 4 BATTERY [used to save feature programming]), and one recessed pushbutton (labeled RESET).

Near the bottom left of the KSU is a 50-pin connector, labeled STATIONS 10 TO 15, that is used to connect the KSU to the station wiring main distribution frame (MDF) — and, through the MDF, to all the system stations.

The KSU's power cord (at the top of the KSU) plugs into a 110 V ac outlet (at the appropriate time; see the Connection Procedures section). A grounding wire (12 AWG, solid copper) connects from the top of the KSU to a ground clamp, usually on a water pipe.

An input connector for an optional 24 V backup battery is also provided at the top of the KSU. If ac power is lost, the switchover to backup battery power is automatic when the optional backup battery is connected.

The unit comes with 4 screws for mounting the KSU on a backboard.

### Up to Six Telephone Sets

#### Part Number 90-0291 (non-handsfree)

or

#### Part Number 90-0292 (handsfree with busy lamp field)

Other than the handsfree operation and the busy lamp field, these two models look alike and operate identically. For example, both have an attractive black matte finish.

Each Set's base has six dual-function station select/speed dial keys (labeled 10 through 15 — the top key is also used for last number Redial), three line select keys (labeled 1, 2, and 3), seven dedicated function keys (labeled Hold, Flash/Cancel, Conference, Intercom, Speed, Speaker, and Mic.on/off) and a tone dial keypad.

The line 1, 2, and 3 keys, the Intercom key, and the Mic.on/off key have accompanying status indicators. And, only on handsfree/busy lamp field (HF/BLF) Sets, each station select key (10 through 15) also has an accompanying status indicator.

Finally, the base has a speaker volume control (a sliding adjustment) and a ringer control switch (a 3-position switch, for low, medium, and high volume ringing).

Each Set also includes a telephone handset and two modular cords — a 4-conductor, coiled cord for connecting the handset to the Set, and a 4-conductor modular cord for connecting the Set to the station wiring jack.



### OPTIONAL COMPONENTS

#### **One Door Answer Unit, Part Number 90-0058, With One or Two Door Modules, Part Number 90-0057**

The Door Answer Unit (also known as the Door Answer Control) is installed next to, and connects with, the KSU. It serves as the interface between the system's stations and the one or two installed Door Modules (also known as the Door Answer Boxes) at the desired doors or entryways. Together, these units enable signaling and conversation between Set users and visitors. Like the KSU, these units come equipped with mounting screws.

A visitor, by pressing the door bell button on a Door Module, generates a distinctive tone (four groups of 4 short tones for Door Module 1, four groups of 2 long tones for Door Module 2) that will sound at all Sets programmed to ring on line 3 and causes the indicator for line 3 on all Sets to WINK. Also, each Set user can generate a calling tone that will sound at Door Module 1 only.

#### **One Power Fail Transfer Unit Part Number 90-0052**

The Power Fail Transfer Unit automatically takes over in the event of an electrical power failure, allowing for continued telephone service during the emergency. When power fails, the Power Fail Transfer Unit transfers the system's CO lines (all 3 of them — or the 2 lines in use, if the optional Door Answer Unit with Door Modules is installed) to pre-installed *standard* telephone sets (*not* to Panther 306 Sets).

#### **Up to Five Off Premises Extension/ Data Interface (OPX) units Part Number 90-0308**

The OPX unit converts a 4-wire interface to a 2-wire interface, allowing a single line telephone to be connected to any spare station jack — except station 10. It also allows 2-wire devices to be connected at a distance greater than the system 2000 feet limit for Sets. The OPX unit also simulates CO line characteristics, allowing a modem or an answering machine to be connected to the system. Finally, the OPX unit allows a remote device to be connected to your system at any distance via a CO line.

When the user lifts the single-line telephone's handset, an intercom connection is made to the Panther system. Also, by dialing a special code, the off-premise user can access any of the Panther system's outside lines.

#### **Set Stands/Wall-Mounts Part Number 90-0087**

Each Set may be placed on a desk — or mounted on a wall using the Set Stand/Wall-Mount Bracket (available in packages of 10).

The same bracket can also be used to provide a heightened viewing angle when used with the Set on a desk- or table-top.

**Designation Cards**

**Part Number 90-0296**  
**(for non-handsfree Sets)**

**or**

**Part Number 90-0297**  
**(for handsfree/busy lamp field Sets)**

Designation Cards are used to list the first five private speed call numbers and identify the assignment or location of the six system stations.

Although each Set comes equipped with one installed and one spare Designation Card, you may order additional cards (in packages of 10) for your system.

Notice that each type of Set uses a *different* Designation Card.

**Face Plates**

**Part Number 70-0211**  
**(for non-handsfree Sets)**

**or**

**Part Number 70-0212**  
**(for handsfree/busy lamp field Sets)**

Face Plates cover and protect the Designation Cards. You may order spare Face Plates for your system.

Notice that each type of Set uses a *different* Face Plate.

**CONNECTORS**

<i>Equipment</i>	<i>Jacks/Connections</i>	<i>Cable Pairs</i>
CO or PBX lines .....	Modular RJ14C and RJ11C.....	A total of 3 (one per line)
KSU:		
CO1.2 and CO3.....	Modular RJ14C and RJ11C .....	2 and 1
STATIONS 10 TO 15 (to station wiring MDF)....	50-pin R21C to 66-block.....	25
DOOR (to Door Answer Unit jack DA).....	Modular RJ25C.....	3
POWER FAIL (to Power Fail Transfer Unit).....	Special connector.....	(See Power Fail Transfer Unit)
MUSIC (music input — 50 mV rms).....	Mini-Jack (1/8-inch, phono).....	1
External battery .....	Molex connector .....	1
Ground .....	Screw terminal .....	Single 12 AWG, solid copper wire
Station wiring MDF (to station jacks).....	66-block to modular RJ14C.....	2 each*
Panther 306 Sets (to station jacks).....	Modular RJ14C (or RJ25C**)...	2 each, cord supplied (or 3**)
Door Module (to Door Answer Unit D1 and D2).....	Screw terminals.....	1 to each module
Power Fail Transfer Unit (optional):		
CO1.2 & CO3.4 (from incoming lines).....	Modular RJ14C and RJ11C.....	2 and 1
TK1.2 & TK3.4 (to KSU jacks CO1.2 & CO3.4).	Modular RJ14C and RJ11C.....	2 and 1
CNJ (to KSU jack POWER FAIL).....	Special connector.....	1 (cable supplied)

**ENVIRONMENTAL REQUIREMENTS**

Operating Temperature.....	0 to 40 °C (32 to 104 °F)
Relative Humidity.....	Less than 90%, non-condensing

**POWER REQUIREMENTS**

Voltage.....	115 V ac (± 10%), 50/60 Hz
Current.....	1.0 A, maximum load

**STATION NUMBERING PLAN**

Panther 306 Sets or OPX units.....	10 through 15 (OPX unit not allowed on station 10)
------------------------------------	--

**SYSTEM CAPABILITIES**

CO or PBX Lines (each independently programmable for DTMF or pulse signaling).....	3 (only 2 with Door Answer Unit)
Intercom Speech Paths.....	3
Stations (any mixture of non-handsfree and handsfree/BLF Sets or OPX units).....	Up to 6
Speed Call Numbers (up to 26 digits, pauses, or flashes each):	
Common (system-wide).....	Up to 34
Private.....	Up to 11 at each Set
Door Answer Unit (optional) .....	1 (with 1 or 2 Door Modules)
Power Fail Transfer Unit (optional).....	1†

\* Length of each station cable should not exceed 2000 feet of 24 AWG; all station runs are star (home run) configurations  
 \*\* Sets may alternatively use a 6-conductor modular cord-to-RJ25C jack (to gain access to the Set's speaker terminals)  
 † Transfers up to 3 incoming lines to pre-installed *standard* telephone sets (*not* Panther 306 Sets) in the event of a power failure

**STEP 1**  
**INSTALLING THE KSU**

**Site Preparation**

Because the KSU is at the heart of the operation of the Panther 306 Electronic Key Telephone System, ensure that its installation site meets the following criteria:

- Clean, dry, and well ventilated (should meet the environmental requirements listed in Section C)
- Within seven feet of the incoming CO, CENTREX, or PBX line terminations

**WARNING**

If you are in area subject to power transients, install a surge protector on the dedicated outlet.

- Within five feet of a *dedicated* 110 V ac, 60 Hz, 3-wire grounded outlet — an outlet that is *not* on a wall switch
- Not too distant from station terminations (the maximum distance to each station is 2000 feet, using 24 AWG wiring)
- A 30" by 30" area of wall space should be reserved, allowing room for the Power Fail Transfer Unit and Door Answer Unit (whether they are being installed now or might be in the future)

**Backboard Installation**

If the KSU is to be mounted on a concrete or masonry wall, the use of a 1/2-inch thick plywood backboard (30 inches square) is recommended.

Depending on the wall's construction and your method of installing the backboard, you might need screwdrivers (various kinds and sizes), drills and bits (various sizes), # 10 masonry screws with plastic anchors (4 of each), or 1/4" screws with wall grip screw anchors (4 of each).

Mount the backboard at least 12 inches above the floor.

**System Uncrating**

- a Carefully unpack the System and confirm that all ordered parts are present by checking them off against the Customer's order sheet and the packing list.
- b Make sure that the customer's feature requirements have been documented on a Customer Feature Selection Form.

**KSU Installation**

- a Mark the position of the 4 screw holes needed to mount the KSU on the backboard.
- b Drive four screws (supplied) until their heads are within 1/8-inch of the board's surface.
- c Using the four keyhole slots (narrow end up) in the side flanges of the KSU cabinet, hang the unit on the four screws and tighten them securely.

**CAUTION**

Failure to properly ground the KSU may void your Panther 306 Electronic Key Telephone System warranty.

- d Connect the ground lug at the top of the KSU to a cold water metal pipe or ground stake, using copper wire that is 12 AWG or heavier (not supplied).

Be sure that the cold water pipe's metal continuity is not broken by the use of plastic pipe.

A ground stake should also meet the installation requirements of your local electrical code.

- e At the electrical service panel, equip the electrical breaker for this outlet with a locking clip — or mark it with a label to serve notice that this unit should not be disconnected or shut off.

## STEP 2 CONNECTING INCOMING TELEPHONE LINES

### WARNING

Do not plug in the KSU's power cord until instructed to do so in Step 4.

### NOTES

1. If telephone lines 1 and 2 are not yet installed, ask the telco that they be terminated in a single 4-conductor RJ14 jack.
2. If line 3 is also not yet installed, ask that it be terminated in an RJ11 jack.
3. If the optional Power Fail Transfer Unit is to be installed, follow the instructions in Step 9 to connect the incoming lines.
4. If the optional Door Answer Unit is to be installed, line 3 (KSU jack CO3) must be left vacant.
5. Refer to the Typical System Layout Diagram (on page E-1) for wiring details.

If the incoming lines are terminated in RJ14 jacks — with lines 1 and 2 terminated in a *single* RJ14 jack — simply install one 4-conductor, modular line cord between the single RJ14 jack at which incoming lines 1 and 2 both terminate and the jack labeled CO1.2 on the left side of the KSU.

If, however, the incoming lines 1 and 2 are already terminated in *separate* RJ11 jacks, use a 2-line to modular RJ14 adapter (such as SE-174 from Suttle Apparatus Corporation) to form a bridge to the KSU jack labeled CO1.2.

Then, install a 2-conductor modular cord between the RJ11 jack at which incoming line 3 terminates and the jack labeled CO3 on the left side of the KSU.

## STEP 3 INSTALLING STATION WIRING

### WARNING

To prevent damage to the KSU while wiring, make sure that the KSU's power cord is not plugged in. Do not apply power to the KSU until instructed to do so in Step 4.

### NOTES

1. Because much of the feature programming is performed from station 10, choose a convenient or strategic location for station 10.
2. If an external amplifier/speaker is to be used at any of the station locations, mount a 6-conductor RJ25 jack at the station location instead of a 4-conductor RJ14 jack. See Step 10.
3. Refer to the Typical System Layout Diagram (on page E-1) and the Station Wiring Table (on the facing page) for wiring details.
  - a. Decide on the location and station number (from 10 up through 15) for each Set.
  - b. Mount a 4-conductor RJ14 jack within 6 feet of the desired Set location at each station.
  - c. On the backboard, mount a 66-block with a female 50-pin connector.
  - d. Install a 25-pair cable — with male 50-pin connectors at both ends — between the 66-block's 50-pin connector and the KSU 50-pin connector labeled STATIONS 10 TO 15. Secure the KSU end of the cable with the screw and plastic tie-wrap provided with the unit.
  - e. For each station, install a length (not to exceed 2000 feet) of 4-conductor, 24 AWG cable from the 66-block terminals to the station wiring jack.

Station Number	Circuit Function	4-Conductor Station Jack†	66-Block Terminal	50-Pin Connector	25-Pair Cable*
10	voice (tip)	green (GN)	1	26	white/blue
	voice (ring)	red (RD)	2	1	blue/white
	data (tip)	black (BK)	3	27	white/orange
	data (ring)	yellow (YL)	4	2	orange/white
11	voice (tip)	green (GN)	5	28	white/green
	voice (ring)	red (RD)	6	3	green/white
	data (tip)	black (BK)	7	29	white/brown
	data (ring)	yellow (YL)	8	4	brown/white
12	voice (tip)	green (GN)	9	30	white/slate
	voice (ring)	red (RD)	10	5	slate/white
	data (tip)	black (BK)	11	31	red/blue
	data (ring)	yellow (YL)	12	6	blue/red
13	voice (tip)	green (GN)	13	32	red/orange
	voice (ring)	red (RD)	14	7	orange/red
	data (tip)	black (BK)	15	33	red/green
	data (ring)	yellow (YL)	16	8	green/red
14	voice (tip)	green (GN)	17	34	red/brown
	voice (ring)	red (RD)	18	9	brown/red
	data (tip)	black (BK)	19	35	red/slate
	data (ring)	yellow (YL)	20	10	slate/red
15	voice (tip)	green (GN)	21	36	black/blue
	voice (ring)	red (RD)	22	11	blue/black
	data (tip)	black (BK)	23	37	black/orange
	data (ring)	yellow (YL)	24	12	orange/black

† Use matching color codes for the 4-conductor station wiring cables.  
\* The first color listed is the predominant color; the second color listed is the tracer or stripe color.

**Station Wiring Table**

## STEP 4 CONDUCTING THE INITIAL SYSTEM AND STATION TESTS

### NOTE

If the indications described below do not occur, refer to the Troubleshooting section.

- a. Connect the KSU power cord to the surge protector previously installed at the 110 V ac power outlet: the recessed STATUS indicator goes ON (with a slight flicker) indicating that the KSU is operative.
- b. Set KSU switch 4 BATTERY to ON (if necessary, use a paper clip or other pointed object such as a pen or pencil to set the KSU miniature DIP switches)
- c. Set KSU switch 1 PROGRAM to ON.
- d. Push the recessed RESET pushbutton once.
- e. Set KSU switch 1 PROGRAM to OFF.
- f. Push the recessed RESET pushbutton again: the system is now set the factory preprogrammed conditions (for details on what those conditions are, see the Feature Programming section).
- g. At station 10, plug in the 4-conductor modular cord supplied with the set between the Set and the station wiring jack.
- h. Press the Set's **Intercom** key: the Set's speaker emits a continuous tone and the **Intercom** indicator goes ON.
- i. Lift the handset and press the line 2 key: dial tone is heard; the **Intercom** indicator goes OFF; if yours is a BLF Set, *your* station indicator goes ON; and the line 2 indicator WINKS slowly.
- j. Hang up the handset: dial tone is removed; and the line 2 indicator goes OFF.

- k. Repeat steps i and j for line 1 — and line 3, if not used for the Door Answer Unit.
- l. Repeat steps g through k for the remaining stations.

Unless you have optional items to install (the Door Answer Unit, the Power Fail Transfer Unit, OPX units, or a music source), your Panther 306 Electronic Key Telephone System is now ready for programming or operation.

## STEP 5 CONNECTING THE BACKUP BATTERY

The KSU has a white plastic Molex connector at its top for connecting an external backup battery. The backup battery used (such as the TRI 24/2.5B from Alpha Technologies) should provide 24 V dc at 2 Amps for an extended period of time.

- a. Connect the positive (+) terminal of the battery (usually the red lead) to the left side of the KSU connector.
- b. Connect the negative (-) terminal of the battery (usually the black lead) to the right side of the KSU connector.

## STEP 6 CONNECTING DOOR ANSWER UNIT AND DOOR MODULES

### NOTE

If you have chosen to install the Door Answer Unit with its one or two Door Modules, the line connector labeled CO 3 must be left vacant.

### Door Answer Unit Installation

- a. Mount the Door Answer Unit on the backboard along with the KSU, using the four screws supplied with the equipment.

- b. Connect a 6-conductor modular cord (not supplied) to the connector labeled DOOR on the KSU and the connector labeled DA on the Door Answer Unit.

### Door Module Installation

- a. Remove the screw securing the Door Modules' front cover, and separate the front from the back.
- b. Mount the backs of the Door Modules at the desired entryway locations, using the two mounting screws furnished with each Door Module.
- c. Run a length (not to exceed 2000 feet) of 2-conductor, 24 AWG wire from the Door Answer Unit to each Door Module.
- d. Feed the wire through the hole in the base of the back of the Door Module.
- e. Strip the cable end and secure it to the screw terminals found on the backside of the Door Module's front assembly.
- f. Replace the Door Module's cover and tighten the screw to secure the front to the back.
- g. At the Door Answering Unit, strip the cable ends and secure the cable from Door Module 1 to the screw terminals labeled D1 and the cable from Door Module 2 to the screw terminals labeled D2.

### Door Answer Unit Test

#### NOTE

If the indications described below do not occur, refer to the Troubleshooting section.

- a. Door Module 1-initiated calling:
  - i. At Door Module 1's entryway, have someone press the door button: four groups of 4 short tones are heard at all Sets programmed to ring on line 3; and the line 3 indicator FLASHES slowly.

- ii. At any Set, pick up the handset and press the line 3 key: the line 3 indicator WINKS; if yours is a BLF Set, *your* station indicator goes ON; and you and the person at the entryway are connected.

- iii. At the Set, hang up the handset: all indicators go OFF; and the call is terminated.

- b. Set-initiated calling:

#### NOTE

Set-initiated door module intercom calls can only be *placed* to Door Module 1, not to Door Module 2.

- i. Alternatively, at any Set, pick up the handset and press the line 3 key: the line 3 indicator WINKS; if yours is a BLF Set, *your* station indicator goes ON; and the person at Door Module 1 hears a burst of ringing.

- ii. At the entry way where Door Module 1 is installed, the person responds by speaking in the direction of the Door Module: you and the person at the entryway are connected.

- iii. At the Set, hang up the handset: all indicators go OFF; and the call is terminated.

- c. Door Module 2-initiated calling:

- i. At Door Module 2's entryway, have someone press the door button: four groups of 2 long tones are heard at all Sets programmed to ring on line 3; and the line 3 indicator FLASHES slowly.

- ii. At any Set, pick up the handset and press the line 3 key: the line 3 indicator WINKS; if yours is a BLF Set, *your* station indicator goes ON; and you and the person at the entryway are connected.

- iii. At the Set, hang up the handset: all indicators go OFF; and the call is terminated.



### STEP 7

## CONNECTING THE MUSIC SOURCE

### Music Connection

- a. Connect one end of the cable (not supplied) into the music source's output jack.
- b. Connect the other end, which terminates in a 1/8-inch mini-jack (phono, not stereo or attenuator), into the KSU connector labeled MUSIC.

### Music Test

#### NOTE

If the indications described below do not occur, refer to the Troubleshooting section.

- a. Turning background music on at a Set:
  - i. At any station, with the handset in its cradle, press the **Intercom** Key: the **Intercom** indicator WINKS slowly; and a continuous tone is heard over the Set's speaker.
  - ii. With the handset still in its cradle, dial \* 4: the **Intercom** indicator goes OFF; and the continuous tone is replaced by background music coming from the Set's speaker.
  - iii. At the music source, adjust the level of the background music for the desired loudness.
- b. Turning background music off at a Set:
  - i. At any station, with the handset in its cradle press the **Intercom** Key: the **Intercom** indicator WINKS slowly; and a continuous tone is heard over the Set's speaker.
  - ii. With the handset still in its cradle, dial \* 4: the **Intercom** indicator goes OFF; and neither the continuous tone nor the background music is heard over the Set's speaker.
- c. Testing the background music on hold:
  - i. Have someone call in on outside line 1 (alternatively, you can call line 1 from line 2): ringing is heard at all stations programmed to ring on line 1; and the line 1 indicator FLASHES slowly.
  - ii. At any station, pick up the handset and press the line 1 Key: the line 1 indicator WINKS slowly; if yours is a BLF Set, *your* station indicator goes ON; and a connection is made with the outside caller.
  - iii. After informing the outside caller of your intentions, press the **Hold** key and hang up the handset: the line 1 indicator FLASHES quickly; if yours is a BLF Set, *your* station indicator goes OFF; and the outside caller hears the background music.
  - iv. After a few seconds, retrieve the call by picking up the handset and pressing the line 1 key: the line 1 indicator WINKS slowly; if yours is a BLF Set, *your* station indicator goes ON; the outside caller no longer hears the background music; and the connection with the outside caller is restored.
  - v. Confirm the success of the background music on hold test with the outside caller.
  - vi. Hang up the handset: all indicators go OFF; and the call is terminated.

**STEP 8**  
**CONNECTING THE OPX UNIT**

**OPX Unit Connection**

**NOTES**

1. The OPX unit may be installed at any station location — except station 10.
  2. See also the Typical System Layout Diagram on page E-2.
- a. Mount the OPX unit next to the desired station location, using the four screws supplied with the equipment.
  - b. Plug the small dc connector into the OPX unit's POWER connector and plug the wall connector into an unswitched, grounded 115 V ac outlet.
  - c. Connect the modular cord (not supplied) between the station wiring jack and the KSU jack on the OPX unit.

**NOTE**

If the device to be used is remotely located (not to exceed 2 miles on a direct connection), a 2-conductor, RJ11 jack can be mounted and wired to the remote device.

Alternatively, the remote device can be accessed through a CO line (with no limits on distance). FCC rules require that you tell the telco that the OPX's Facility Interface Code is 0L13B and its Service Code is 9.0F.

In either case, the 2-conductor cord in step d will then be connected between the RJ11 jack and the TEL jack on the OPX unit.

- d. Connect a 2-conductor cord between the TEL jack on the OPX unit and the 2-line device to be used (such as a standard set, answering machine, or modem).
- e. If access to an outside line is desired in the event of a power failure, connect a spade-to-modular, 2-conductor cord between one of the incoming lines (in parallel with the normal system connection) and the PFT jack on the OPX unit.
- f. Set the A-B switch on the OPX unit to B.

**OPX Unit Test**

**NOTE**

If the indications described below do not occur, refer to the Troubleshooting section.

- a. Originating internal calls:
  - i. At the standard set connected to the OPX unit, pick up the handset: a continuous tone is heard.
  - ii. Call another station by dialing its 2-digit number, such as **13**: at the called station, repeated long tones are heard.
  - iii. The called party picks up the handset: the tones stop; and you and the called party are connected.
  - iv. Hang up the handset to terminate the call.
- b. Receiving internal calls:
  - i. Have someone place an internal call to the station at which the OPX unit is installed: your set rings.
  - ii. Pick up the handset: the ringing stops; and you and the calling party are connected.
  - iii. Hang up the handset to terminate the call.
- c. Placing outside calls:
  - i. At the standard set connected to the OPX unit, pick up the handset: a continuous tone is heard.
  - ii. Request outside line 1 by dialing **\*01**: an external dial tone is heard.
  - iii. Complete the outside call by dialing the desired number. Hang up, when finished, to terminate the call.
  - iv. Test access to outside line 2 and outside line 3 (unless the optional Door Answer Unit is installed) by repeating steps i through iii above for outside lines 2 and 3.

### STEP 9 CONNECTING THE POWER FAIL TRANSFER UNIT

#### NOTE

Perform the following procedure only if you wish to install the optional Power Fail Transfer Unit. If such is the case, then this procedure should be followed *in lieu of* Step 2.

#### CAUTION

Power should not yet be applied to the KSU.

### Power Fail Transfer Unit Installation

#### NOTE

See also the Power Fail Transfer Unit diagram in the System and Set Layout section.

- a. Mount the Power Fail Transfer Unit in the upper right corner of the plywood backboard.
- b. Connect the 2-conductor special cable supplied with the Power Fail Transfer Unit, as follows:
  - i. At the KSU, connect one end of the special cable to the connector labeled POWER FAIL.
  - ii. At the Power Fail Transfer Unit, connect the other end of the special cable into the connector labeled CNK.
- c. Route the incoming lines to the Power Fail Transfer Unit:
  - i. Connect a 4-conductor modular cord between the single RJ14 jack at which incoming lines 1 and 2 are terminated and the Power Fail Transfer Unit jack labeled CO1.2.
  - ii. Connect a 2-conductor modular cord between the single RJ11 jack at which incoming line 3 is terminated and the Power Fail Transfer Unit jack labeled CO3.4.
- d. Route the lines from the Power Fail Transfer Unit to the KSU:
  - i. Connect a 4-conductor modular cord between the Power Fail Transfer Unit jack labeled TK1.2 and the KSU jack labeled CO1.2.
  - ii. Connect a 4-conductor modular cord between the Power Fail Transfer Unit jack labeled TK3.4 and the KSU jack labeled CO3.
- e. Install three *standard* telephones (2-wire sets) in convenient or strategic locations.
- f. Using 2-conductor, modular cords, connect the standard sets to the jacks labeled T1T through T3T on the Power Fail Transfer Unit.

### Power Fail Transfer Unit Test

- a. With power still removed from the KSU, the standard sets just installed should all be receiving dial tone — and be able to originate and receive outside calls. If not, refer to the Troubleshooting section.
- b. Proceed to Step 3.

### STEP 10 INSTALLING AN EXTERNAL AMPLIFIER/SPEAKER

If an external amplifier/speaker is to be installed at a given station, the the standard station wiring and Set installation procedures must be modified for that station as follows (see also the diagram to the right):

- a. Instead of mounting a 4-conductor RJ14 jack at the station location (see Step 3 b), mount a 6-conductor RJ25 jack.

#### NOTE

The 4-conductor station wiring cable between the 66-block terminals and the station wiring jack still follows the details given in the station wiring table on page D-3 — with the 4 wires still running from the same 66-block terminals and being installed color-to-color on the jack, green-to-green, red-to-red, black-to-black, and yellow-to-yellow.

- b. Connect the external amplifier to the blue and white terminals of the RJ25 station wiring jack.
- c. Instead of using the 4-conductor modular cord supplied with the Set (see Step 4 g), use a standard 6-conductor modular cord to connect the Set to the station wiring jack.

#### NOTE

The external amplifier/speaker is now connected to the Set's speaker terminals.

- d. Check to see that signaling and voice messages normally heard over the Set's speaker will now be heard over the external amplifier/speaker.
- e. To return the Set to its normal operation, simply replace the 6-conductor cord between the Set and the station wiring jack with the 4-conductor that was originally supplied with the Set.

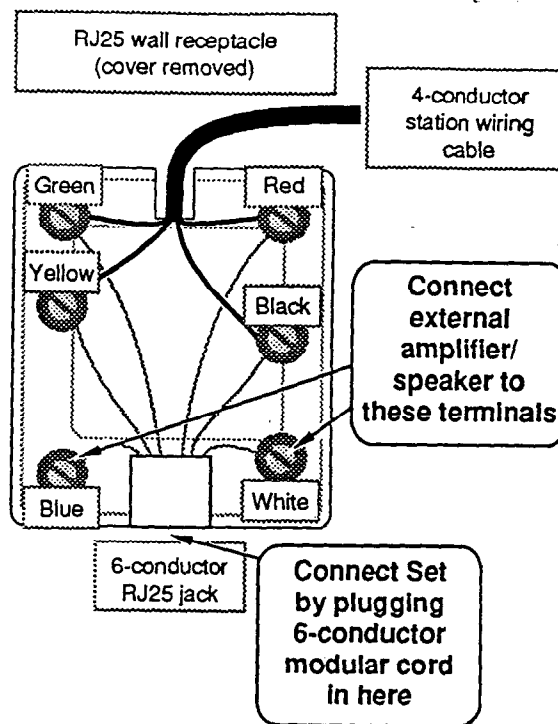

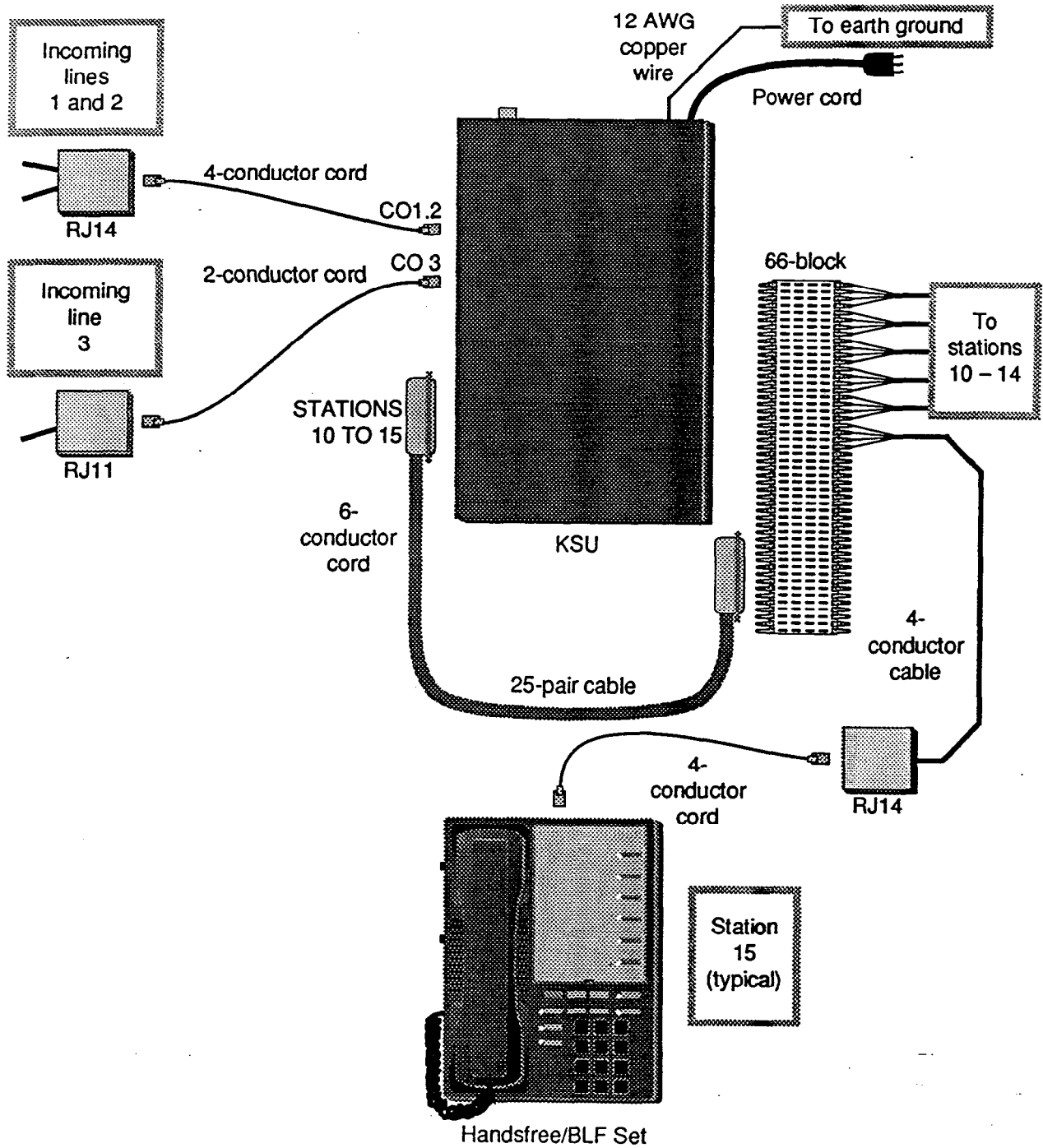

TYPICAL SYSTEM LAYOUT DIAGRAM (Standard Components only)

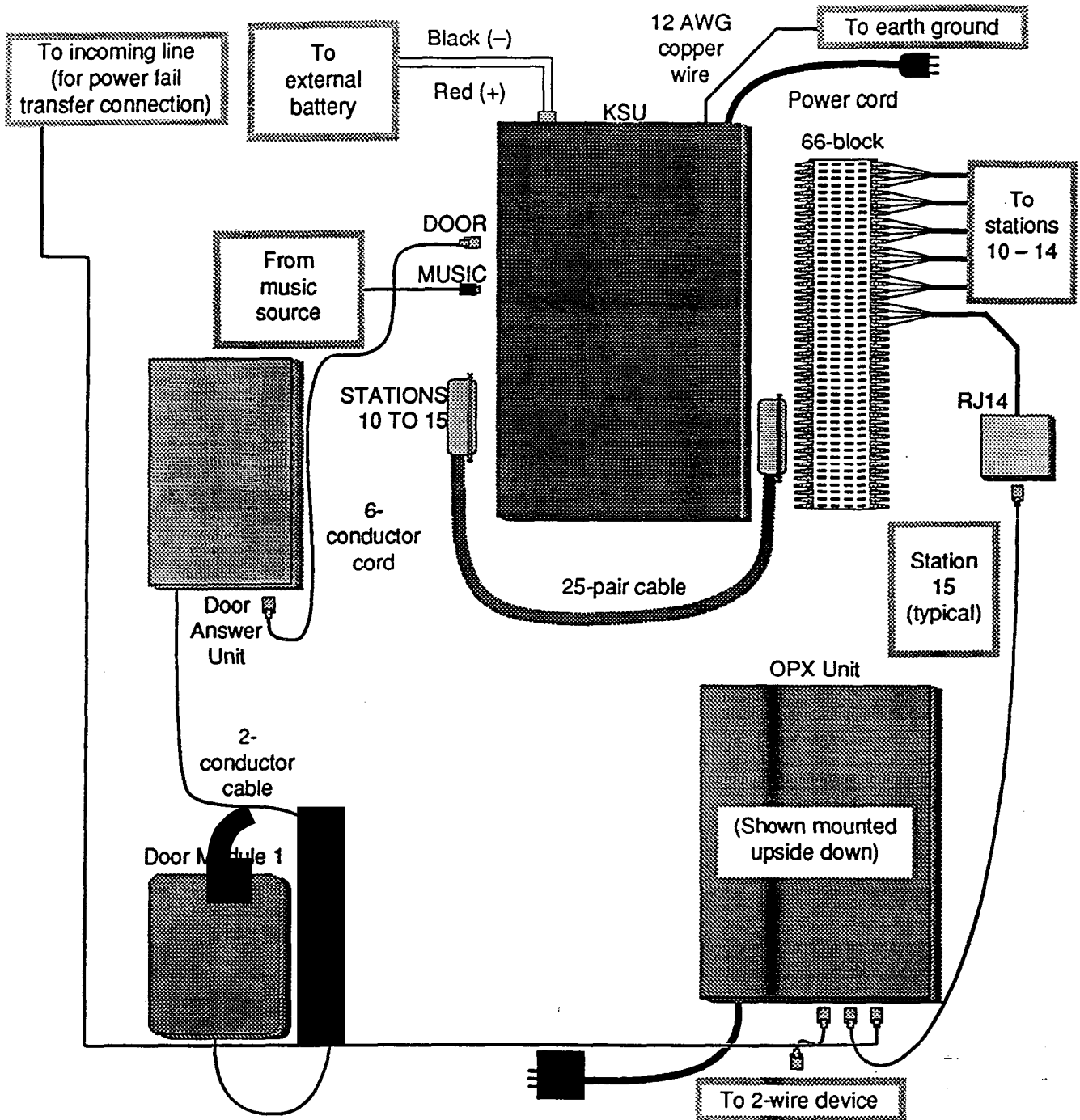

TYPICAL SYSTEM LAYOUT DIAGRAM (Optional and External Components only)

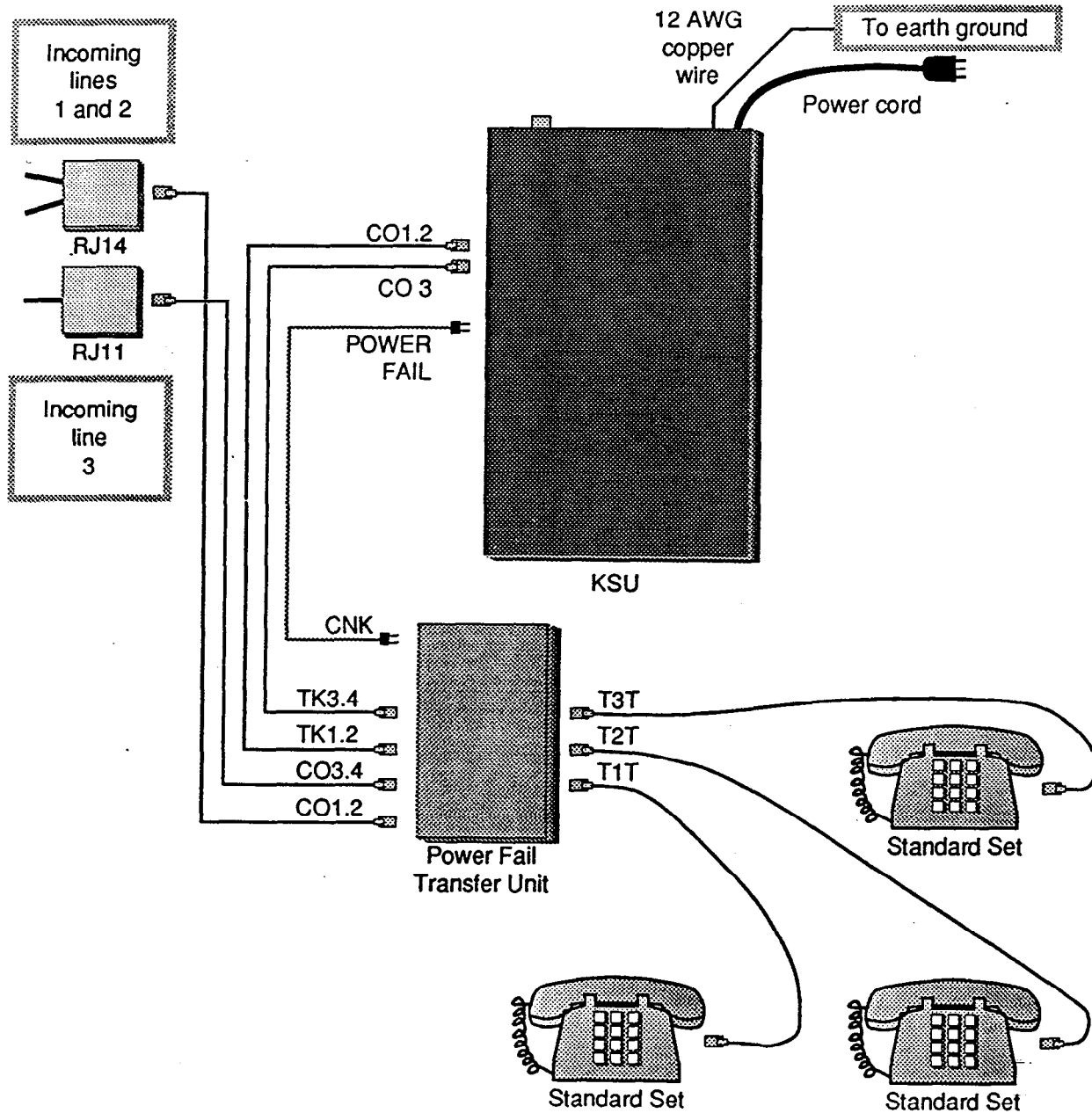

TYPICAL POWER FAIL TRANSFER UNIT LAYOUT DIAGRAM

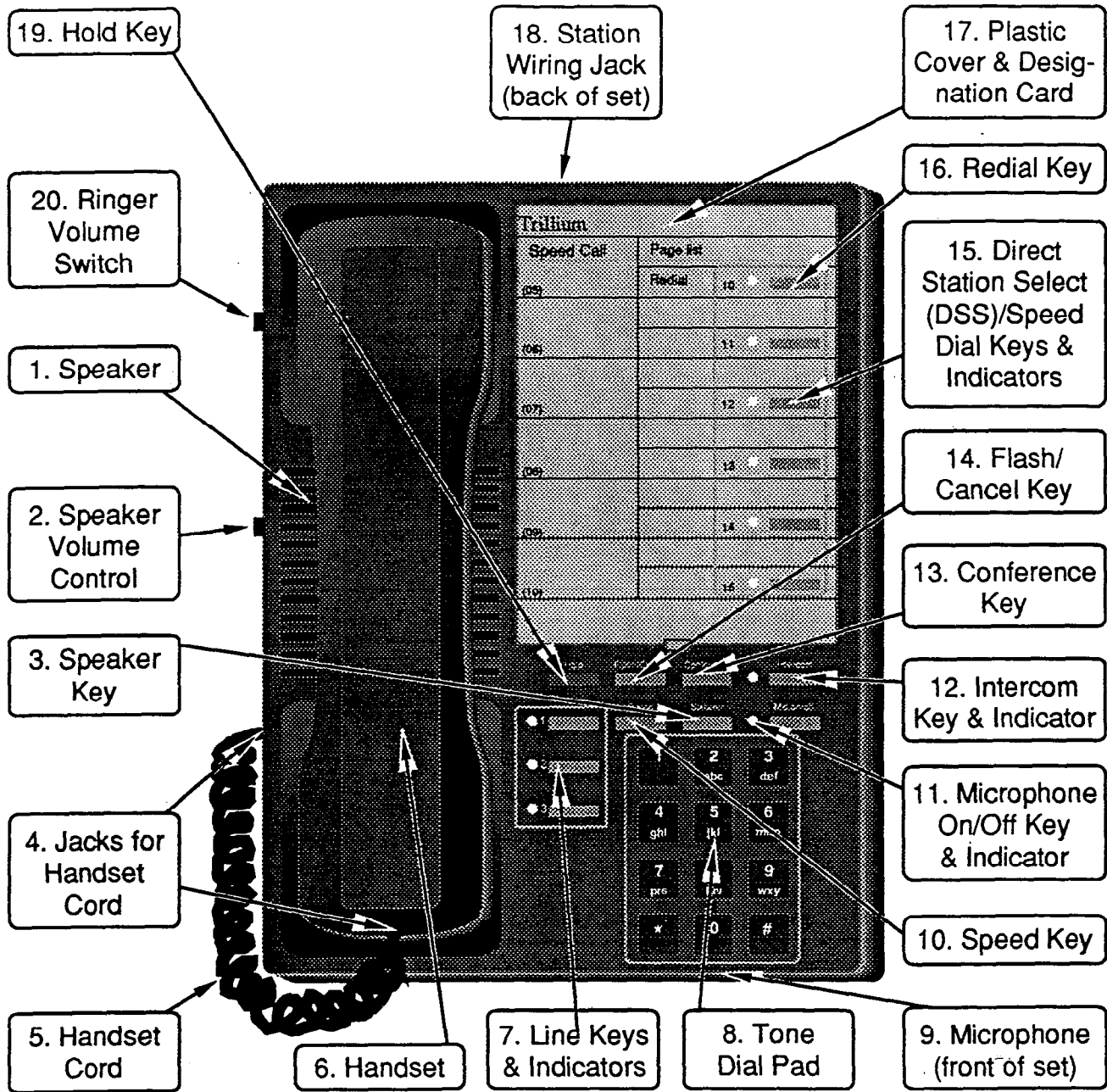

SET LAYOUT DIAGRAM



## SET LAYOUT

1. The speaker allows the user to monitor the progress of outside calls — and, with the Handsfree/Busy Lamp Field (HF/BLF) Set (as illustrated), to operate in a handsfree (speakerphone) mode. The speaker may also be used to listen to background music, when available, on both non-handsfree and handsfree Sets.
2. The speaker volume control (not labeled) adjusts the loudness of sounds emitted by the speaker.
3. The **Speaker** key is used to turn the Set's speaker on and off — and, with handsfree Sets, to conclude a handsfree call.

With handsfree Sets, in auto line, the **Speaker** key selects CO line; in auto intercom, the **Speaker** key selects intercom (see Manual/Auto Select feature).

4. Two jacks (one on the base of the handset and the other on the left side of the Set) accept the plugs on the handset cord supplied with the Set.
5. The handset cord (supplied) connects the handset with the Set.
6. The handset transmits and receives voice signals.
7. The line keys (1 through 3) select the indicated outside lines (unless programmed differently), and the corresponding indicators show the status of the outside lines.  
The keys and indicators are also used in feature programming.  
NOTE: Line 3 is used for door answering, rather than as an outside line, when the Door Answer Unit is installed.
8. The tone dial pad is used in making calls and feature programming.

In addition, two of these keys — when dialed first *with the handset in its cradle* — have special operating significance:

# automatically selects the internal intercom line.

\* automatically selects the last outside line used at your Set.

9. The microphone detects and amplifies voice conversation to enable handsfree operation (not present on non-handsfree Sets).

10. The **Speed** key is used to dial private and common speed call numbers; it also used to enter private and common speed call numbers into system memory.
11. The **Mic.on/off** key turns the Set's microphone off and on. The indicator goes ON (lights) when the microphone is turned on; the indicator is also used in feature programming.
12. The **Intercom** key and indicator are used together or independently in setting the Do Not Disturb feature, making All Page, Zone Page, and other intercom calls, monitoring rooms, and activating the Barge-In feature.  
They are also used in feature programming.
13. The **Conference** key sets up 3-party calls.
14. The **Flash/Cancel** key is used as either a precise length (programmable) hookswitch flash or as cancel key— but not both:  
As a hookswitch flash, it is used for accessing PBX, CENTREX, and other network features.  
As a cancel key, it terminates external calls in progress and returns a dial tone to the user — without having to hang up the handset.
15. The direct station select (DSS)/speed dial keys are used for selecting the indicated internal stations — and, except for the top key (see 16, below), for dialing private speed call numbers.  
The indicators show the status of the other system stations but appear only on HF/BLF Sets.
16. The **Redial** key redials the last number manually dialed from your Set and serves as the DSS key for station 10.
17. The plastic cover protects the Designation Card, which is used to keep track of private speed call numbers and station assignments. HF/BLF and non-handsfree sets use *different* Designation Cards and Face Plates.
18. The station wiring jack is used to connect your Set to the station wiring; use the modular cord supplied with your Set.
19. The **Hold** key is used to place calls on temporary hold.
20. The ringer volume switch is a 3-position slide switch used to control the loudness of ringing at your Set.

## FEATURE CATEGORIES

You may program five different categories of features on your Panther 306 Electronic Key Telephone System: system-wide features that apply to all sets and all lines, such as Hold Recall Time and Auto Hold; individual Set features that apply only to selected stations, such as Ringing Assignments and Night Transfer Ringing; individual line features that apply only to selected lines, such as Tone or Pulse dialing and Loud Bell Ringing; individual group features that apply only to selected groups, such as Line Grouping; and, finally, speed call numbers divided into 34 common speed call numbers (codes 20-53), available at all Sets, and 11 private speed call numbers, unique to each individual Set.

System-wide features, individual Set features, individual line features, individual group features, and common speed call numbers can only be programmed from the Set assigned as station 10.

Individual speed call numbers, on the other hand, may be programmed by Set users from their own individual Sets.

## Categories Versus Codes

Programmable features are assigned to program codes — and sometimes more than one feature is assigned to a given program code. For example, the Auto Hold and Manual/Auto Select programmable features are both assigned to program code 0001.

Programming all features that have the same program code *at the same time* is an efficient way to program the Panther 306 Electronic Key System *when it is first installed*.

However, as system requirements change, programming only the individual feature or features that need modification becomes the most straightforward approach.

The feature programming procedures and tables in this section are organized by *feature category* and, within each category, *alphabetically by feature name* — not numerically by program code. (The feature descriptions located at the end of this section are arranged simply in alphabetical order by feature name.) Thus, all these materials are designed to support system *changes*, rather than system installation.

## Referencing Categories to Codes

However, to help during system installation, a table — organized by program code numbers — is provided on the next two pages, that provides references to the feature programming procedures, feature programming tables, and feature descriptions that make up the balance of this section.

## Interrelated Features

Moreover, as listed below (in program code sequence within each group), certain features are directly or indirectly interrelated (features *not* listed in any group below are judged to be relatively *independent* of other features).

Whenever you program or reprogram one of the features in one of these interrelated groups, you should consider whether a corresponding change is required to the other features found in the same group.

### Behind PBX/CENTREX-Related Features

Flash or Cancel (0011), Pause on Number (0020), Pause Time (0050), Flash or Cancel Duration (0060), and Telephone or PBX Line (5XX0)

### Group-Related Features

Line Group Type (0011), Line Group Assignment (3YY0), and Line Grouping (6ZZ0 & 6ZZ1)

### Hold-Related Features

Auto Hold (0001 and Hold Recall Time (0000)

### Restriction-Related Features

Digits-to Deny (0051), Call Restrictions (1YY1), Barge-In (4YY0), Incoming Calls Only (5XX0), and Flexible Call Restrictions (7000-7900)

### Ringing-Related Features

Ringing Assignment (2YY0) and Night Transfer Ringing (4YY0)

### Tone/Pulse-Related Features

Interdigit Pause (0010), Pulse Rate (0010), Make-Break Ratio (0010), Tone Duration (0011), and Tone or Pulse (5XX0)

# Feature Programming

Technical  
Service  
Manual

Feature Name	Program Code	Feature Category	Preprogrammed Condition	Programming and Description Page References
Common (20-53)	None	Speed Calling	None	Programming: F-14/Description: see Section G
Private Numbers	None	Speed Calling	None	Programming: F-15/Description: see Section G
Hold Recall Time	0000	System-wide	No recall	Programming: F-4 & F-6/Description: F-16
Auto Hold	0001	System-wide	No auto hold	Programming: F-4 & F-5/Description: F-15
Manual/Auto Select	0001	System-wide	Auto intercom	Programming: F-4 & F-7/Description: F-17
Interdigit Pause	0010	System-wide	800 milliseconds	Programming: F-4 & F-6/Description: F-16
Make-Break Ratio	0010	System-wide	40 %	Programming: F-4 & F-6/Description: F-16
Pulse Rate	0010	System-wide	10 pulses per second	Programming: F-4 & F-7/Description: F-17
Flash or Cancel	0011	System-wide	Cancel	Programming: F-4 & F-5/Description: F-16
Line Group Type	0011	System-wide	Type A	Programming: F-4 & F-6/Description: F-16
Tone Duration	0011	System-wide	100 milliseconds	Programming: F-4 & F-7/Description: F-17
Pause on Number	0020	System-wide	No pause	Programming: F-4 & F-7/Description: F-17
Pause Time	0050	System-wide	3 seconds	Programming: F-4 & F-7/Description: F-17
Digits-to-Deny	0051	System-wide	8th digit	Programming: F-4 & F-5/Description: F-15
Flash or Cancel Duration	0060	System-wide	1 second	Programming: F-4 & F-5/Description: F-16

Feature Programming Cross-Reference Table (Sheet 1 of 2)

Feature Name	Program Code*	Feature Category	Preprogrammed Condition	Programming and Description Page References
Call Restrictions	1YY1	Individual Set	Class A	Programming: F-8 & F-9/Description: F-15
Ringing Assignment	2YY0	Individual Set	No ringing†	Programming: F-8 & F-9/Description: F-17
Line Group Assignment	3YY0	Individual Set	No group	Programming: F-8 & F-9/Description: F-16
Zone Paging	3YY1	Individual Set	No zones	Programming: F-8 & F-9/Description: F-17
Barge-In	4YY0	Individual Set	No barge-in	Programming: F-8 & F-9/Description: F-15
Night Transfer Ringing	4YY0	Individual Set	No ringing	Programming: F-8 & F-9/Description: F-17
Incoming Calls Only	5XX0	Individual line	No	Programming: F-10 & F-11/Description: F-16
Telephone or PBX Line	5XX0	Individual line	Telephone	Programming: F-10 & F-11/Description: F-17
Tone or Pulse	5XX0	Individual line	Tone	Programming: F-10 & F-11/Description: F-17
Line Grouping	6ZZ0	Individual group	All lines††	Programming: F-12 & F-13/Description: F-16
Flexible Call Restrictions	None or 7000-7900	System-wide	None	Programming: F-4 & F-6/Description: F-16

- \* YY stands for desired station number (10 through 15); XX stands for desired line number (01 through 03); and ZZ stands for desired group number (01 through 12).
- † Station 10 is preprogrammed to ring on all lines; all other stations are preprogrammed not to ring on any line.
- †† If the Line Group Assignment feature (code 3YY0) is programmed for any condition other than no group (its preprogrammed condition) -- that is, if any Sets have been assigned to any group -- then the preprogrammed condition is for all outside lines to be assigned to each active group.

**Feature Programming Cross-Reference Table (Sheet 2 of 2)**

## SYSTEM-WIDE FEATURES

### CAUTION

Set BATTERY to ON at the KSU to prevent loss of entered feature programming selections.

To program system-wide features from station 10, ...

Step	Action	Response
<b>First enter the programming mode:</b>		
1	At the KSU, set PROGRAM 2 to ON.	...
2	At the KSU, press RESET.	At station 10, the <b>Mic.on/off</b> indicator FLASHES after a few seconds.

Then, to program a selected feature:

3*	Dial the selected program code.	The <b>Mic.on/off</b> indicator goes OFF.
4*	Program the desired condition for the selected feature by pressing the line 1, 2, and 3 keys and the <b>Intercom</b> key — or by dialing a specified number, using the key pad, if so instructed.	The indicators for lines 1, 2, and 3 and the indicator for <b>Intercom</b> display the pattern shown in the table that starts on the facing page.
5	Press the <b>Hold</b> key.	The <b>Mic.on/off</b> indicator FLASHES.

Then, to program another feature (if all desired features have been programmed, go to step 7):

6	Return to step 3.	...
---	-------------------	-----

Finally, to exit the programming mode and save all your programming selections:

7	At the KSU, set PROGRAM 2 to OFF.	...
8	At the KSU, press RESET.	At station 10, the <b>Mic.on/off</b> indicator goes OFF.

To return all features to their preprogrammed (factory default) conditions ...

Step	Action	Response
1	At the KSU, set PROGRAM 1 to ON.	...
2	At the KSU, press RESET.	...
3	At the KSU, set PROGRAM 1 to OFF.	...
4	At the KSU, press RESET again.	...

### NOTE

System-wide features may be programmed in any order. Also, you may program as many or as few features as you desire. Therefore, in the table that starts on the facing page, features are listed in alphabetical order to help you find the features you want quickly.

\* See the Program Code, Condition Description, and Indicator Status column entries in the feature programming table that starts on the facing page.

Feature Name	Program Code	Feature Category	Condition Description*	Indicator Status
Auto Hold	0001	System-wide	No auto hold Auto hold	Line 1 off Line 1 on
Digits-to-Deny	0051	System-wide	No digits (00)** 1st digit (01)** 2nd digit (02)** 3rd digit (03)** 4th digit (04)** 5th digit (05)** 6th digit (06)** 7th digit (07)** 8th digit (08)** 9th digit (09)** 10th digit (10)** 11th digit (11)** 12th digit (12)** 13th digit (13)** 14th digit (14)** 15th digit (15)**	<b>Intercom</b> and lines 1, 2, and 3 off Line 1 on; <b>Intercom</b> and lines 2 and 3 off Line 2 on; <b>Intercom</b> and lines 1 and 3 off Lines 1 and 2 on; <b>Intercom</b> and line 3 off Line 3 on; <b>Intercom</b> and lines 1 and 2 off Lines 1 and 3 on; <b>Intercom</b> and line 2 off Lines 2 and 3 on; <b>Intercom</b> and line 1 off Lines 1, 2, and 3 on; <b>Intercom</b> off <b>Intercom</b> on; lines 1, 2, and 3 off <b>Intercom</b> and line 1 on; lines 2 and 3 off <b>Intercom</b> and line 2 on; lines 1 and 3 off <b>Intercom</b> and lines 1 and 2 on; line 3 off <b>Intercom</b> and line 3 on; lines 1 and 2 off <b>Intercom</b> and lines 1 and 3 on; line 2 off <b>Intercom</b> and lines 2 and 3 on; line 1 off <b>Intercom</b> and lines 1, 2, and 3 on
Flash or Cancel	0011	System-wide	<b>Cancel</b> Flash	Line 2 off Line 2 on
Flash or Cancel Duration	0060	System-wide	20 milliseconds (00)** 40 milliseconds (01)** 60 milliseconds (02)** 80 milliseconds (03)** 100 milliseconds (04)** 200 milliseconds (05)** 300 milliseconds (06)** 400 milliseconds (07)** 500 milliseconds (08)** 600 milliseconds (09)** 700 milliseconds (10)** 800 milliseconds (11)** 900 milliseconds (12)** 1 second (13)** 2 seconds (14)** 3 seconds (15)**	<b>Intercom</b> and lines 1, 2, and 3 off Line 1 on; <b>Intercom</b> and lines 2 and 3 off Line 2 on; <b>Intercom</b> and lines 1 and 3 off Lines 1 and 2 on; <b>Intercom</b> and line 3 off Line 3 on; <b>Intercom</b> and lines 1 and 2 off Lines 1 and 3 on; <b>Intercom</b> and line 2 off Lines 2 and 3 on; <b>Intercom</b> and line 1 off Lines 1, 2, and 3 on; <b>Intercom</b> off <b>Intercom</b> on; lines 1, 2, and 3 off <b>Intercom</b> and line 1 on; lines 2 and 3 off <b>Intercom</b> and line 2 on; lines 1 and 3 off <b>Intercom</b> and lines 1 and 2 on; line 3 off <b>Intercom</b> and line 3 on; lines 1 and 2 off <b>Intercom</b> and lines 1 and 3 on; line 2 off <b>Intercom</b> and lines 2 and 3 on; line 1 off <b>Intercom</b> and lines 1, 2, and 3 on

\* Preprogrammed (factory default) conditions are shown in bold type.

\*\* Dial the number in parentheses using the key pad; observe that the desired indicator pattern appears (see Indicator Status column).

System-Wide Feature Programming Table (Sheet 1 of 3)

# Feature Programming

Feature Name	Program Code	Feature Category	Condition Description*	Indicator Status
Flexible Call Restrictions	None	System-wide	<b>None</b>	(Ignore indicator pattern)
	7100		(---)†	(Ignore indicator pattern)
	7200		(---)†	(Ignore indicator pattern)
	7300		(---)†	(Ignore indicator pattern)
	7400		(---)†	(Ignore indicator pattern)
	7500		(---)†	(Ignore indicator pattern)
	7600		(---)†	(Ignore indicator pattern)
	7700		(---)†	(Ignore indicator pattern)
	7800		(---)†	(Ignore indicator pattern)
	7900		(---)†	(Ignore indicator pattern)
7000	(---)†	(Ignore indicator pattern)		
Hold Recall Time	0000	System-wide	<b>No recall</b>	Lines 1 and 2 off
			1.5 minutes	Line 1 on; line 2 off
			3 minutes	Line 2 on; line 1 off
			3 minutes; release @ 5	Lines 1 and 2 on
Interdigit Pause	0010	System-wide	<b>800 milliseconds</b>	<b>Intercom</b> and line 3 off
			1100 milliseconds	Line 3 on; <b>Intercom</b> off
			700 milliseconds	<b>Intercom</b> on; line 3 off
			500 milliseconds††	<b>Intercom</b> and line 3 on
Line Group Type	0011	System-wide	<b>Type A</b>	<b>Intercom</b> and line 3 off
			Type B	Line 3 on; <b>Intercom</b> off
			Type C	<b>Intercom</b> on; line 3 off
			Type D	<b>Intercom</b> and line 3 on
Make-Break Ratio	0010	System-wide	<b>40%</b>	Line 1 off
			30%††	Line 1 on

\* Preprogrammed (factory default) conditions are shown in bold type.

† After dialing the Program Code, dial a 3-digit sequence *not* to be called (to be restricted), such as 411, a specific area code, or an exchange prefix; to keep track of entered call restrictions, write them down (in pencil) in the space provided between parentheses. Cancel an entry by pressing the Conference key after dialing the indicated Program Code.

†† This value is not permitted when the Panther system is to be installed in Canada or connected to the Canadian Telephone Network.

## System-Wide Feature Programming Table (Sheet 2 of 3)

Feature Name	Program Code	Feature Category	Condition Description*	Indicator Status
Manual/Auto Select	0001	System-wide	<b>Auto intercom</b> Manual select Auto line	Lines 2 and 3 off Line 2 on; line 3 off Line 3 on; line 2 off
Pause on Number	0020	System-wide	<b>No pause</b> Pause on 7 Pause on 8 Pause on 9 Pause on 0	<b>Intercom</b> and lines 1, 2, and 3 off Line 1 on† Line 2 on† Line 3 on† <b>Intercom</b> on†
Pause Time	0050	System-wide	1 second (00)** 1 second (01)** 2 seconds (02)** 3 seconds (03)** 4 seconds (04)** 5 seconds (05)** 6 seconds (06)** 7 seconds (07)** 8 seconds (08)** 9 seconds (09)** 10 seconds (10)** 11 seconds (11)** 12 seconds (12)** 13 seconds (13)** 14 seconds (14)** 15 seconds (15)**	<b>Intercom</b> and lines 1, 2, and 3 off Line 1 on; <b>Intercom</b> and lines 2 and 3 off Line 2 on; <b>Intercom</b> and lines 1 and 3 off Lines 1 and 2 on; <b>Intercom</b> and line 3 off Line 3 on; <b>Intercom</b> and lines 1 and 2 off Lines 1 and 3 on; <b>Intercom</b> and line 2 off Lines 2 and 3 on; <b>Intercom</b> and line 1 off Lines 1, 2, and 3 on; <b>Intercom</b> off <b>Intercom</b> on; lines 1, 2, and 3 off <b>Intercom</b> and line 1 on; lines 2 and 3 off <b>Intercom</b> and line 2 on; lines 1 and 3 off <b>Intercom</b> and lines 1 and 2 on; line 3 off <b>Intercom</b> and line 3 on; lines 1 and 2 off <b>Intercom</b> and lines 1 and 3 on; line 2 off <b>Intercom</b> and lines 2 and 3 on; line 1 off <b>Intercom</b> and lines 1, 2, and 3 on
Pulse Rate	0010	System-wide	<b>10 pulses per second</b> 20 pulses per second††	Line 2 off Line 2 on
Tone Duration	0011	System-wide	<b>100 milliseconds</b> 75 milliseconds	Line 1 off Line 1 on

\* Preprogrammed (factory default) conditions are shown in bold type.

\*\* Dial the number in parentheses using the key pad; observe that the desired indicator pattern appears (see Indicator Status column).

† Any combination of numbers 7 through 0 to pause on can be programmed by pressing the indicated keys; observe that the corresponding indicators go ON.

†† This pulse rate is not permitted when the Panther system is to be installed in Canada or connected to the Canadian Telephone Network.

System-Wide Feature Programming Table (Sheet 3 of 3)



# Feature Programming

## INDIVIDUAL SET FEATURES

### CAUTION

Set BATTERY to ON at the KSU to prevent loss of entered feature programming selections.

To program individual Set features from station 10, ...

Step	Action	Response
<b>First enter the programming mode:</b>		
1	At the KSU, set PROGRAM 2 to ON.	...
2	At the KSU, press RESET.	At station 10, the Mic.on/off indicator FLASHES after a few seconds.

Then, to program a selected feature at a selected station:

3*	Dial the selected program code: dial the first digit, then the 2-digit number of the selected Set (10 through 15 — represented by YY), and finally the last digit.	The Mic.on/off indicator goes OFF.
4*	Program the desired condition for the selected feature by pressing the line 1, 2, and 3 keys and the Intercom key — or by dialing a specified number, using the key pad, if so instructed.	The indicators for lines 1, 2, and 3 and the indicator for Intercom display the pattern shown in the table on the facing page.
5	Press the Hold key.	The Mic.on/off indicator FLASHES.

Then, to program another Set — or another feature (if all desired features have been programmed, go to step 7):

6	Return to step 3.	...
---	-------------------	-----

Finally, to exit the programming mode and save all your programming selections:

7	At the KSU, set PROGRAM 2 to OFF.	...
8	At the KSU, press RESET.	At station 10, the Mic.on/off indicator goes OFF.

To return all features to their preprogrammed (factory default) conditions ...

Step	Action	Response
1	At the KSU, set PROGRAM 1 to ON.	...
2	At the KSU, press RESET.	...
3	At the KSU, set PROGRAM 1 to OFF.	...
4	At the KSU, press RESET again.	...

### NOTE

Individual Set features may be programmed in any order. Also, you may program as many or as few features or Sets as you desire. Therefore, in the table on the facing page, features are listed in alphabetical order to help you find the features you want quickly.

\* See the Program Code, Condition Description, and Indicator Status column entries in the feature programming table on the facing page.

Feature Name	Program Code†	Feature Category	Condition Description*	Indicator Status
Barge-In	4YY0	Individual Set	No barge-in Barge-in	Intercom off Intercom on
Call Restrictions	1YY1	Individual Set	Class A Class B Class C	Lines 1 and 2 off Line 1 on; line 2 off Line 2 on; line 1 off
Line Group Assignment	3YY0	Individual Set	No group (00)** Group 1 (01)** Group 2 (02)** Group 3 (03)** Group 4 (04)** Group 5 (05)** Group 6 (06)** Group 7 (07)** Group 8 (08)** Group 9 (09)** Group 10 (10)** Group 11 (11)** Group 12 (12)**	Intercom and lines 1, 2, and 3 off Line 1 on; Intercom and lines 2 and 3 off Line 2 on; Intercom and lines 1 and 3 off Lines 1 and 2 on; Intercom and line 3 off Line 3 on; Intercom and lines 1 and 2 off Lines 1 and 3 on; Intercom and line 2 off Lines 2 and 3 on; Intercom and line 1 off Lines 1, 2, and 3 on; Intercom off Intercom on; lines 1, 2, and 3 off Intercom and line 1 on; lines 2 and 3 off Intercom and line 2 on; lines 1 and 3 off Intercom and lines 1 and 2 on; line 3 off Intercom and line 3 on; lines 1 and 2 off
Night Transfer Ringing	4YY0	Individual Set	No transfer Transfer	Line 2 off Line 2 on
Ringing Assignment	2YY0	Individual Set	No ringing††† Ring on line 1 calls Ring on line 2 calls Ring on line 3 calls***	Lines 1, 2, and 3 off†† Line 1 on†† Line 2 on†† Line 3 on††
Zone Paging	3YY1	Individual Set	No zones (00)** Zone 1 (01)** Zone 2 (02)** Zone 3 (03)** Zone 4 (04)** Zone 5 (05)** Zone 6 (06)**	Intercom and lines 1, 2, and 3 off Line 1 on; Intercom and lines 2 and 3 off Line 2 on; Intercom and lines 1 and 3 off Lines 1 and 2 on; Intercom and line 3 off Line 3 on; Intercom and lines 1 and 2 off Lines 1 and 3 on; Intercom and line 2 off Lines 2 and 3 on; Intercom and line 1 off

† YY stands for desired station number (10 through 15).

†† A Set may be programmed to ring on any or all of the incoming lines by pressing the indicated keys; observe that the corresponding indicators go ON.

††† Station 10 is preprogrammed to ring on all lines; all other stations are preprogrammed not to ring on any line.

\* Preprogrammed (factory default) conditions are shown in bold type.

\*\* Dial the number in parentheses using the key pad; observe that the desired indicator pattern appears (see Indicator Status column).

\*\*\* Rings when door button is pressed on Door Module 1 or 2 (if optional Door Answer Unit is installed).

### Individual Set Feature Programming Table

## INDIVIDUAL LINE FEATURES

### CAUTION

Set BATTERY to ON at the KSU to prevent loss of entered feature programming selections.

To program individual line features from station 10, ...

Step	Action	Response
<b>First enter the programming mode:</b>		
1	At the KSU, set PROGRAM 2 to ON.	...
2	At the KSU, press RESET.	At station 10, the <b>Mic.on/off</b> indicator FLASHES after a few seconds.

Then, to program a selected feature for a selected line:

3*	Dial the selected program code: dial the first digit, then the 2-digit number of the selected line (01 through 03 — represented by XX), and finally the last digit.	The <b>Mic.on/off</b> indicator goes OFF.
4*	Program the desired condition for the selected feature by pressing the line 1, 2, and 3 keys and the <b>Intercom</b> key.	The indicators for lines 1, 2, and 3 and the indicator for <b>Intercom</b> display the pattern shown in the table on the facing page.
5	Press the <b>Hold</b> key.	The <b>Mic.on/off</b> indicator FLASHES.

Then, to program another line — or another feature (if all desired features have been programmed, go to step 7):

6	Return to step 3.	...
---	-------------------	-----

Finally, to exit the programming mode and save all your programming selections:

7	At the KSU, set PROGRAM 2 to OFF.	...
8	At the KSU, press RESET.	At station 10, the <b>Mic.on/off</b> indicator goes OFF.

To return all features to their preprogrammed (factory default) conditions ...

Step	Action	Response
1	At the KSU, set PROGRAM 1 to ON.	...
2	At the KSU, press RESET.	...
3	At the KSU, set PROGRAM 1 to OFF.	...
4	At the KSU, press RESET again.	...

### NOTE

Individual line features may be programmed in any order. Also, you may program as many or as few features or lines as you desire. Therefore, in the table on the facing page, features are listed in alphabetical order to help you find the features you want quickly.

\* See the Program Code, Condition Description, and Indicator Status column entries in the feature programming table on the facing page.

Feature Name	Program Code†	Feature Category	Condition Description*	Indicator Status
Incoming Calls Only	5XX0	Individual line	No Yes	Line 3 off Line 3 on
Telephone or PBX Line	5XX0	Individual line	<b>Telephone</b> PBX	Line 2 off Line 2 on
Tone or Pulse	5XX0	Individual line	<b>Tone</b> Pulse	Line 1 off Line 1 on

† XX stands for desired line number (01 through 03).

\* Preprogrammed (factory default) conditions are shown in bold type.

**Individual Line Feature Programming Table**

### INDIVIDUAL GROUP FEATURES

#### CAUTION

Set BATTERY to ON at the KSU to prevent loss of entered feature programming selections.

To program individual group features from station 10, ...

Step	Action	Response
<b>First enter the programming mode:</b>		
1	At the KSU, set PROGRAM 2 to ON.	...
2	At the KSU, press RESET.	At station 10, the <b>Mic.on/off</b> indicator FLASHES after a few seconds.

Then, to program a selected feature for a selected group:

3*	Dial the selected program code: dial the first digit, then the 2-digit number of the desired group (01 through 12 — represented by ZZ), and finally the last digit.	The <b>Mic.on/off</b> indicator goes OFF.
4*	Program the desired condition for the selected feature by pressing the line 1, 2, and 3 keys and the <b>Intercom</b> key.	The indicators for lines 1, 2, and 3 and the indicator for <b>Intercom</b> display the pattern shown in the table on the facing page.
5	Press the <b>Hold</b> key.	The <b>Mic.on/off</b> indicator FLASHES.

Then, to program another group — or another feature (if all desired features have been programmed, go to step 7):

6	Return to step 3.	...
---	-------------------	-----

Finally, to exit the programming mode and save all your programming selections:

7	At the KSU, set PROGRAM 2 to OFF.	...
8	At the KSU, press RESET.	At station 10, the <b>Mic.on/off</b> indicator goes OFF.

To return all features to their preprogrammed (factory default) conditions ...

Step	Action	Response
1	At the KSU, set PROGRAM 1 to ON.	...
2	At the KSU, press RESET.	...
3	At the KSU, set PROGRAM 1 to OFF.	...
4	At the KSU, press RESET again.	...

\* See the Program Code, Condition Description, and Indicator Status column entries in the feature programming table on the facing page.

Feature Name	Program Code†	Feature Category	Condition Description*	Indicator Status
Line Grouping	6ZZ0	Individual group	<b>All lines**</b> Remove line 1 Remove line 2 Remove line 3	Lines 1, 2, and 3 on†† Line 1 off†† Line 2 off†† Line 3 off††

† ZZ stands for desired group number (01 through 12).

†† Any line or combination of lines may be assigned to a group by not pressing the desired line keys; observe that the corresponding indicators are ON.

\* Preprogrammed (factory default) conditions are shown in bold type.

\*\* If the Line Group Assignment feature (code 3YY0) is programmed for any condition other than no group (its preprogrammed condition) — that is, if any Sets have been assigned to any group — then the preprogrammed condition is for all outside lines to be assigned to each active group.

**Individual Group Feature Programming Table**

## SPEED CALL NUMBERS

### Speed Call Programming Notes

#### NOTES

1. Entries up to 26 digits long may be stored as speed call numbers.

2. Pressing the Hold key as part of the speed call number programming sequence inserts a halt in the dialing sequence; pressing the Flash/Cancel key inserts a hookswitch flash; and pressing the Conference key inserts a pause.

You may insert as many halts, flashes, and pauses as you wish as long as the total key entry count does *not* exceed 26.

3. Up to 34 common speed call numbers may be programmed into the system — but only from station 10.

Additionally, up to 11 private speed call numbers may be programmed at each individual station.

## Common Speed Call Numbers

### NOTE

During common speed call number programming, the user at station 10 will leave the station's handset in its cradle and listen to the indicated aural responses over the speaker.

**To program up to 34 common speed call numbers into the system from station 10 ...**

Step	Action	Response
1	Press the <b>Speed</b> key.	A continuous tone is heard over the Set's speaker; and the <b>Intercom</b> indicator WINKS slowly.
2	Dial the desired speed call code (from 20 to 53).	The <b>Intercom</b> indicator FLASHES.
3	Dial the number you wish to store for the selected speed call code.	The continuous tone stops; and the <b>Intercom</b> indicator continues to FLASH.

**To program another speed call number:**

4.	Return to step 1.	...
----	-------------------	-----

**To stop speed call number programming:**

5.	Press the <b>Speaker</b> key.	The <b>Intercom</b> indicator goes OFF; and the Set returns to normal operation.
----	-------------------------------	--

Private Speed Call Numbers

NOTE

During private speed call number programming, the station user will leave the station's handset in its cradle and listen to the indicated aural responses over the speaker.

To program up to 11 private speed call numbers into the system ...

Step	Action	Response
1	Press the <b>Speed</b> key.	A continuous tone is heard over the Set's speaker, and the <b>Intercom</b> indicator WINKS slowly.
2	For the first 5 speed call numbers, press the desired station/speed call key (11 to 15); for the last 6 private speed call numbers, dial the desired speed call code (05 to 10).	The <b>Intercom</b> indicator FLASHES.
3	Dial the number you wish to store for the selected speed call key.	The continuous tone stops; and the <b>Intercom</b> indicator continues to FLASH.

To program another speed call number:

4.	Return to step 1.	...
----	-------------------	-----

To stop speed call number programming:

5.	Press the <b>Speaker</b> key.	The <b>Intercom</b> indicator goes OFF; and the Set returns to normal operation.
----	-------------------------------	--

FEATURE DESCRIPTIONS

NOTE

Since the same 5 keys are used to select stations and to select one of your first 5 private speed call numbers, the **SPEED** key must be pressed before pressing the desired private speed call key when dialing one of your first 5 private speed call numbers *with auto hold enabled*.

**Auto Hold** (program code 0001, preprogrammed for no auto hold) — allows a call to be simultaneously placed on hold and transferred by pressing the desired station select key.

**Barge-In** (program code 4YY0, preprogrammed for no barge-in) — allows selected stations to override the privacy feature and enter an outside call that is in progress; an intrusion tone is sounded to alert the call-in-progress parties of the barge-in.

**Call Restrictions** (program code 1YY1, preprogrammed for Class A) — assigns stations to one of three call restriction classes:

Class A = no restrictions

Class B = prevented from dialing 0 or 1 as the first digit, from dialing the number of digits to deny (see **Digits-to-Deny**), or from dialing any of the specific restriction entries (see **Flexible Call Restrictions**)

Class C = no outside calls can be placed (but intercom calls can be placed or received, and incoming outside calls can be received, depending on line group programming).

**Digits-to-Deny** (program code 0051, preprogrammed for the 8th digit) — determines which digit will be denied on a dialing attempt under Class B restrictions (see **Call Restrictions**).



**Flash or Cancel** (program code 0011, preprogrammed for cancel) — defines the function of the **Flash/Cancel** key, hookswitch flash or cancel signal for ending calls. (The length of this signal must be properly set to provide the desired function; refer to **Flash or Cancel Duration**).

### NOTE

Generally, a flash signal is 500 milliseconds long, and a cancel signal is 1 second long; to make sure you choose the correct length, check the specifications for your PBX.

**Flash or Cancel Duration** (program code 0060, preprogrammed for 1 second) — sets the length of the flash or cancel signal (see **Flash or Cancel**).

**Flexible Call Restrictions** (no program code when not programmed, which is the factory default condition; program codes 7000 through 7900 are available for entering up to ten user-defined 3-digit sequences) — allows 3-digit sequences, such as 411 or specific area codes, to be denied for Class B stations (see **Call Restrictions**).

**Hold Recall Time** (program code 0000, programmed for no recall) — enables reminders that you have a call on hold.

**Incoming Calls Only** (program code 5XX0, preprogrammed no — to allow outgoing calls) — allows (no) or prevents (yes) outgoing calls on the indicated lines.

**Interdigit Pause** (program code 0010, preprogrammed for 800 milliseconds) — sets the time between dialed *pulses* (see also **Tone or Pulse**).

**Line Group Assignment** (program code 3YY0, preprogrammed for no group) — assigns the line groups defined under **Line Grouping** to be assigned to the indicated station (see also **Line Group Type**).

**Line Grouping** (program code 6ZZ0, preprogrammed for all lines) — assigns outside lines to one of 12 groups, thereby defining each group. (See also **Line Group Assignment** and **Line Group Type**.)

**Line Group Type** (program code 0011, preprogrammed for Type A) — assigns one of four sets of characteristics to line groups.

### NOTE

The more commonly chosen line group types are Type A and Type D.

Type A = Sets assigned to a line group can only make and answer calls on lines within the group.

Type B = Sets assigned to a line group can make and answer calls on lines within the group — *plus* they can answer calls ringing in another group.

Type C = Sets assigned to a line group can make and answer calls on lines within the group — *plus* they can receive calls transferred from another group.

Type D = Sets assigned to a line group can make and answer calls on lines within the group — *plus* they can answer calls ringing in another group *and* can receive calls transferred from another group.

(See also **Line Group Assignment** and **Line Grouping**.)

**Make-Break Ratio** (program code 0010, preprogrammed for 40 %) — sets the on/off ratio of *pulses* (see also **Tone or Pulse**).

**Manual/Auto Select** (program code 0001, preprogrammed for auto intercom) — determines whether an intercom or external line is selected automatically when the handset is lifted or whether the selection must be made manually when the handset is lifted.

### NOTE

Night transfer ringing should be assigned to at least one station.

**Night Transfer Ringing** (program code 4YY0, preprogrammed for no transfer) — assigns ringing to all lines at the indicated station after business hours, and to the loud bell contacts when night bell is selected under **Loud Bell**.

**Pause on Number** (program code 0020, preprogrammed for no pause) — sets the system for a pause after a specific number or numbers are dialed as the first digit. This feature is used behind a PBX to allow for a second dial tone.

**Pause Time** (program code 0050, preprogrammed for 3 seconds) — sets length of pause for the **Pause on Number** feature and for a pause inserted by the **Conference** key when programming a speed call number.

**Pulse Rate** (program code 0010, preprogrammed for 10 pulses per second) — sets the speed at which *pulses* are transmitted (see also **Tone or Pulse**).

**Ringing Assignment** (program code 2YY0, preprogrammed for no ringing, except station 10 which is preprogrammed to ring on all lines) — chooses which line or lines ring at which station or stations. When the optional Door Answer Unit is installed, line 3 must be programmed to ring at one or more stations.

**Telephone or PBX Line** (program code 5XX0, preprogrammed for telephone line) — tells the KSU which lines are central office (CO) lines and which are PBX/CENTREX lines.

**Tone Duration** (program code 0011, preprogrammed for 100 milliseconds) — sets the length of each tone digit dialed (see also **Tone or Pulse**).

**Tone or Pulse** (program code 5XX0, preprogrammed for tone) — selects tone or pulse signalling for each CO line.

**Zone Paging** (program code 3YY1, preprogrammed for no zones) — places stations into specific zones for receiving zone paging announcements. Zone paging announcements are heard only at stations assigned to a designated zone. A station can be assigned to no more than one zone.

Function	User Action	Set/System Response
<p><b>Background Music</b></p> <p>The optional external music source must be connected.</p>	<p>To turn on background music at your Set, press <b>Intercom</b>.</p> <p>Dial *4.</p> <p>To cancel background music at your Set, press <b>Intercom</b>.</p> <p>Dial *4.</p>	<p>Continuous tone is heard, and <b>Intercom</b> indicator WINKS slowly.</p> <p><b>Intercom</b> indicator goes OFF, and music is heard through your Set's speaker.</p> <p>Continuous tone is heard, and <b>Intercom</b> indicator WINKS slowly.</p> <p><b>Intercom</b> indicator goes OFF, and music is no longer heard through your Set's speaker.</p>
<p><b>Barge-In</b></p> <p>The Barge-In feature must be programmed (enabled) for your Set.</p>	<p>[Non-handsfree*] To enter a call already in progress at another station, lift handset and press <b>Intercom</b>. Press * and the line key of the line you wish to barge in on.</p> <p>[Handsfree*] To enter a call already in progress at another station, press <b>Intercom</b>. Press * and the line key of the line you wish to barge in on.</p>	<p>Continuous tone is heard, and <b>Intercom</b> indicator WINKS slowly. An intrusion tone sounds on the existing call's line to alert the parties to the barge-in, and you are connected to the call on that line.</p> <p>Continuous tone is heard, and <b>Intercom</b> indicator WINKS slowly. An intrusion tone sounds on the existing call's line to alert the parties to the barge-in, and you are connected to the call on that line.</p>
<p><b>Busy Override</b> (responder is on an internal call)</p> <p>Busy override has no effect on a Set that has activated Do Not Disturb.</p> <p>In any event, responder may ignore busy override signals.</p>	<p><i>Initiator:</i> After dialing another station and encountering a broken tone (indicating that the dialed station is busy), press #.</p> <p><i>Responder:</i></p> <p>[Non-handsfree] Hang up and then lift handset.</p> <p>[Handsfree] Press <b>Speaker</b> twice.</p>	<p><i>At the busy station:</i> 3 ringing bursts are heard each time # is pressed.</p> <p><i>At the busy station:</i></p> <p>Existing internal call is disconnected, and you are automatically connected to station initiating busy override signal.</p> <p>Existing internal call is disconnected, and you are automatically connected to station initiating busy override signal.</p>

\* Throughout this Section, where there is an operating difference, the non-handsfree step precedes the *equivalent* handsfree step — perform only one version. The handsfree step requires a Handsfree Set that is *already* in the handsfree operating mode (see Handsfree on page G-7).

# Operating Instructions

Function	User Action	Set/System Response
<p><b>Busy Override</b> (responder is on an outside call)</p> <p>Busy override has no effect on a Set that has activated Do Not Disturb.</p> <p>In any event, responder may ignore busy override signals.</p> <p>If optional external music source is connected, outside party will hear background music while on hold.</p>	<p><i>Initiator:</i> After dialing another station and encountering a broken tone (indicating that the dialed station is busy), press #.</p> <p><i>Responder:</i></p> <p>Press <b>Hold</b>.</p> <p>To retrieve outside call, press appropriate line key.</p>	<p><i>At the busy station:</i> 3 ringing bursts are heard each time # is pressed.</p> <p><i>At the busy station:</i></p> <p>Outside party is placed on hold, line indicator FLASHES quickly, and you are automatically connected to station initiating busy override signal.</p> <p>Line indicator WINKS slowly, and connection is re-established.</p>
<p><b>Call Hold</b> (outside call)</p> <p>If optional external music source is connected, outside party will hear background music while on hold.</p> <p>If so programmed, Hold Recall Time feature sounds reminder signal through speaker <i>after</i> call has been on hold for program-selected period*.</p>	<p>While on outside call, press <b>Hold</b>.</p> <p>[Non-handsfree] To retrieve call, lift handset and press appropriate line key.</p> <p>[Handsfree] To retrieve call, press appropriate line key.</p> <p>[Non-handsfree] To end call, hang up handset.</p> <p>[Handsfree] To end call, press <b>Speaker</b>.</p>	<p>Outside party is placed on hold, and line indicator FLASHES quickly.</p> <p>Line indicator WINKS slowly, and connection is re-established.</p> <p>Line indicator WINKS slowly, and connection is re-established.</p> <p>Line indicator goes OFF, and connection is terminated.</p> <p>Line indicator goes OFF, and connection is terminated.</p>
<p><b>Call Transfer</b> (outside call) — <i>voice announce</i> method</p> <p>If so programmed, Auto Hold feature eliminates need to press <b>Hold</b> since call will automatically be placed on hold when station select key is pressed.</p> <p>If optional external music source is connected, outside party will hear background music while on hold.</p> <p>[continued on next page]</p>	<p><i>Transferring party:</i></p> <p>While on an outside call, press <b>Hold</b>.</p> <p>Press desired station select key.</p> <p>Announce which line call is on. Hang up.</p>	<p><i>At transferring station:</i></p> <p>Outside party is placed on hold, and line indicator FLASHES quickly.</p> <p>Desired station is dialed. (At dialed station, one tone burst is heard, Intercom indicator goes ON, and line indicator FLASHES very slowly.)</p> <p>(Receiving party hears call transfer announcement.)</p>

\* Options include no reminder — or reminder after 1.5 minutes, 3 minutes, or 3 minutes with call release after 5 minutes.

Function	User Action	Set/System Response
<p>Call Transfer (outside call) — <i>voice announce</i> method</p> <p>[continued from previous page]</p>	[Non-handsfree] To retrieve call (if receiving party does not respond), lift handset and press appropriate line key.	Line indicator WINKS slowly, and connection is re-established.
	[Handsfree] To retrieve call (if receiving party does not respond), press appropriate line key.	Line indicator WINKS slowly, and connection is re-established.
	<i>Receiving party:</i>	<i>At receiving station:</i>
	[Non-handsfree] Lift handset and press appropriate line key.	Line indicator WINKS slowly, and connection is established.
<p>Call Transfer (outside call) — <i>internal dialing</i> method</p> <p>If optional external music source is connected, outside party will hear background music while on hold.</p> <p>If so programmed, Hold Recall Time feature sounds reminder signal through speaker <i>after</i> call has been on hold for program-selected period*.</p>	<i>Transferring party:</i>	<i>At transferring station:</i>
	While on an outside call, press <b>Hold</b> .	Outside party is placed on hold, and line indicator FLASHES quickly.
	Press <b>Intercom</b> .	Continuous tone is heard, and <b>Intercom</b> indicator WINKS slowly.
	Dial desired station (10-15). Announce which line call is on. Hang up.	(At dialed station, repeating intercom ringing is heard, <b>Intercom</b> indicator goes ON, and line indicator FLASHES very slowly. Receiving party answers internal call and acknowledges announcement.)
	[Non-handsfree] To retrieve call (if receiving party does not respond), lift handset and press appropriate line key.	Line indicator WINKS slowly, and connection is re-established.
	[Handsfree] To retrieve call (if receiving party does not respond), press appropriate line key.	Line indicator WINKS slowly, and connection is re-established.
	<i>Receiving party:</i>	<i>At receiving station:</i>
	[Non-handsfree] Lift handset and press appropriate line key.	Line indicator WINKS slowly, and connection is established.
[Handsfree] Press appropriate line key.	Line indicator WINKS slowly, and connection is established.	

\* Options include no reminder — or reminder after 1.5 minutes, 3 minutes, or 3 minutes with call release after 5 minutes.

# Operating Instructions

Technical  
Service  
Manual

Function	User Action	Set/System Response
<p><b>Common speed calls</b></p> <p>In handsfree operation, pressing * (as first entry in telephone number sequence) automatically selects last outside line used at station making call.</p>	<p>[Non-handsfree] Lift handset and press outside line key.</p> <p>[Handsfree] Press * or outside line key.</p> <p>Press <b>Speed</b> and dial 2-digit code (20 to 53) for desired speed call.</p>	<p>Dial tone is heard, and line indicator WINKS slowly.</p> <p>Dial tone is heard, and line indicator WINKS slowly.</p> <p>Desired number is automatically dialed.</p>
<p><b>Conferencing</b> (initiator plus 2 outside parties)</p> <p>If optional external music source is connected, outside party will hear background music while on hold.</p> <p>Only one additional outside party can be added.</p>	<p>While on outside call, press <b>Hold</b>.</p> <p>Press another outside line key.</p> <p>Dial (or speed call) third party's telephone number.</p> <p>If third party answers, press <b>Conference</b>, and then press line key of party on hold.</p> <p>Alternatively, to retrieve original call (if third party does not respond), press line key of party on hold.</p> <p>Once conference call is established, to place both outside parties on hold, press <b>Hold</b>.</p> <p>To return to conference call once both parties were placed on hold:</p> <ul style="list-style-type: none"> <li>• Press line key of either outside party.</li> <li>• Press <b>Conference</b> and line key of remaining outside party.</li> </ul> <p>To change to 2-party call once conference call is established, press line key of party you wish to keep.</p>	<p>Outside party is placed on hold, and line indicator FLASHES quickly.</p> <p>Dial tone is heard and selected line indicator WINKS slowly.</p> <p>Call is placed to third party.</p> <p>Conference call is established, and both line indicators WINK slowly.</p> <p>Line indicator WINKS slowly, and connection is re-established.</p> <p>Both outside parties are placed on hold, and both outside line indicators FLASH quickly.</p> <p>...</p> <ul style="list-style-type: none"> <li>• Connection with selected outside party is re-established, and selected line indicator WINKS slowly.</li> <li>• Conference call is re-established, and both line indicators WINK slowly.</li> </ul> <p>Connection with selected outside party remains established (corresponding line indicator continues to WINK slowly), and connection with other outside party</p>

[continued on next page]

Function	User Action	Set/System Response
<p><b>Conferencing</b> (initiator plus 2 outside parties) [continued from previous page]</p>	—	is terminated (other line indicator goes OFF).
<p><b>Conferencing</b> (initiator plus 2 internal parties)</p> <p>Only one additional internal party can be added.</p> <p>Any internal party can end participation in conference call by hanging up handset.</p>	<p>While on internal call, press <b>Conference</b>.</p> <p>Press desired station select key or dial desired 2-digit station number.</p> <p>Make announcement.</p>	<p><b>Intercom</b> indicator WINKS slowly, and continuous tone is heard.</p> <p>Desired station is dialed. (At dialed station, one tone burst is heard, and <b>Intercom</b> indicator goes ON.)</p> <p>Called internal party answers, and conference call is established.</p>
<p><b>Conferencing</b> (initiator plus 1 outside and 1 internal party)</p> <p>If so programmed, Auto Hold feature eliminates need to press <b>Hold</b> since call will automatically be placed on hold when station select key is pressed.</p> <p>If optional external music source is connected, outside party will hear background music while on hold.</p> <p>Only one additional internal party can be added.</p> <p>Any party can end participation in call by hanging up handset.</p>	<p>While on outside call, press <b>Hold</b>.</p> <p>Press desired station select key or dial 2-digit station number.</p> <p>Make announcement.</p> <p>If internal party answers, press <b>Conference</b>, and then press line key of party on hold.</p> <p>To retrieve call (if internal party does not respond), press line key of party on hold.</p>	<p>Outside party is placed on hold, and line indicator FLASHES quickly.</p> <p>Desired station is dialed. (At dialed station, one tone burst is heard, and <b>Intercom</b> indicator goes ON.)</p> <p>...</p> <p>A 3-party mixed conference call is established.</p> <p>Original 2-party call with outside party is re-established, and line indicator WINKS slowly.</p>
<p><b>Do Not Disturb</b></p> <p>Do Not Disturb prevents all calls and paging announcements from ringing at your station. Anyone trying to call will receive broken tone.</p> <p>The <b>Intercom</b> indicator continues to FLASH while Do Not Disturb is activated.</p>	<p>To activate Do Not Disturb, press <b>Intercom</b>.</p> <p>Dial *6.</p> <p>To cancel Do Not Disturb, press <b>Intercom</b>.</p> <p>Dial *6.</p>	<p>Continuous tone is heard, and <b>Intercom</b> indicator WINKS slowly.</p> <p>Tone stops, <b>Intercom</b> indicator FLASHES, and Do Not Disturb is activated.</p> <p>...</p> <p>Continuous tone is heard, and <b>Intercom</b> indicator WINKS slowly.</p> <p>Tone stops, <b>Intercom</b> indicator FLASHES, and Do Not Disturb is canceled.</p>

# Operating Instructions

Technical  
Service  
Manual

Function	User Action	Set/System Response
<p><b>Door Answering</b></p> <p>For station to receive signals from Door Answer Unit, station must be programmed (via Ringing Assignment feature) to receive ringing signals on line 3.</p> <p>Do Not Disturb must also be deactivated.</p>	<p>(Visitor presses door button at entryway.)</p> <p>[Non-handsfree] To answer call from either door module, lift handset and press line 3.</p> <p>[Handsfree] To answer call from either door module, press line 3.</p> <p>[Non-handsfree] To end call with either door module, hang up handset.</p> <p>[Handsfree] To end call with either door module, press <b>Speaker</b>.</p>	<p>Line 3 indicator FLASHES slowly, and appropriately programmed stations will hear signals indicating which entryway visitor is calling from: four groups of 4 short bursts each, if visitor is at Door Module 1; four groups of 2 long bursts each, if visitor is at Door Module 2.</p> <p>Line 3 indicator WINKS slowly, and connection is made with visitor who needs only respond by talking in direction of door module.</p> <p>Line 3 indicator WINKS slowly, and connection is made with visitor who needs only respond by talking in direction of door module.</p> <p>Line 3 indicator goes OFF, and connection with visitor is terminated.</p> <p>Line 3 indicator goes OFF, and connection with visitor is terminated.</p>
<p><b>Door Calling (to Door Module 1 only)</b></p> <p>Calls <i>cannot</i> be placed to Door Module 2.</p>	<p>[Non-handsfree] To place call to Door Module 1, lift handset and press line 3.</p> <p>[Handsfree] To place call to Door Module 1, press line 3.</p> <p>[Non-handsfree] To end call with Door Module 1, hang up handset.</p> <p>[Handsfree] To end call with Door Module 1, press <b>Speaker</b>.</p>	<p>Line 3 indicator WINKS slowly, and one ringing burst is heard at entryway where Door Module 1 is installed. Person being called responds by talking in direction of Door Module 1.</p> <p>Line 3 indicator WINKS slowly, and one ringing burst is heard at entryway where Door Module 1 is installed. Person being called responds by talking in direction of Door Module 1.</p> <p>Line 3 indicator goes OFF, and connection with visitor is terminated.</p> <p>Line 3 indicator goes OFF, and connection with visitor is terminated.</p>



Function	User Action	Set/System Response
<p><b>Exclusive Call Hold (outside call)</b></p> <p>While line is on <b>Exclusive Call Hold</b> at your station, the corresponding line indicator at other stations is ON steadily.</p> <p>If optional external music source is connected, outside party will hear background music while on hold.</p> <p>If so programmed, Hold Recall Time feature sounds reminder signal through speaker <i>after</i> call has been on hold for program-selected period*.</p>	<p>While on outside call, press <b>Hold</b> twice.</p> <p>[Non-handsfree] To retrieve call, lift handset and press appropriate line key.</p> <p>[Handsfree] To retrieve call, press appropriate line key.</p> <p>[Non-handsfree] To end call, hang up handset.</p> <p>[Handsfree] To end call, press <b>Speaker</b>.</p>	<p>Outside party is placed on hold, and line indicator <b>FLASHES</b> very quickly.</p> <p>Line indicator <b>WINKS</b> slowly, and connection is re-established.</p> <p>Line indicator <b>WINKS</b> slowly, and connection is re-established.</p> <p>Line indicator goes <b>OFF</b>, and connection is terminated.</p> <p>Line indicator goes <b>OFF</b>, and connection is terminated.</p>
<p><b>Flash/Cancel</b></p> <p><b>Flash/Cancel</b> can be programmed as flash or as cancel — but not both. See Flash or Cancel feature.</p>	<p>While on an outside call, to use flash, press <b>Flash/Cancel</b>.</p> <p>While on an outside call, to use cancel, press <b>Flash/Cancel</b>.</p>	<p>Call is put on hold; and dial tone is returned.</p> <p>Call is terminated; and dial tone is returned.</p>
<p><b>Handsfree (requires Handsfree Set)</b></p> <p>When <b>Mic.on/off</b> indicator is ON and handset is in cradle, Set is in handsfree operating mode.</p> <p>To end a call while in handsfree mode, press <b>Speaker</b>.</p> <p>To end a call on a Handsfree Set that is operating in a non-handsfree mode — or on a non-handsfree Set — hang up handset.</p>	<p>To enter handsfree mode from non-handsfree mode <i>while handset is in cradle</i>, press <b>Mic.on/off</b>.</p> <p>To enter non-handsfree mode from handsfree mode <i>while handset is in cradle</i>, lift handset.</p> <p>To enter handsfree mode from non-handsfree mode <i>when a call is in progress</i>, press <b>Speaker</b>, make sure that <b>Mic.on/off</b> indicator is ON (press <b>Mic.on/off</b> key if necessary), and hang up handset.</p>	<p><b>Mic.on/off</b> indicator goes ON, and you converse with called parties through the speaker and microphone.</p> <p>You converse with called parties through the handset.</p> <p><b>Mic.on/off</b> indicator stays or goes ON, and you converse with called parties through the speaker and microphone.</p>

\* Options include no reminder — or reminder after 1.5 minutes, 3 minutes, or 3 minutes with call release after 5 minutes.

# Operating Instructions

Technical  
Service  
Manual

Function	User Action	Set/System Response
<p><b>Incoming Call</b></p> <p>The Ringing Assignment feature determines which stations will ring in response to incoming calls — each station can be assigned to anywhere from no outside lines to all outside lines.</p> <p>A station with Do Not Disturb activated will not ring in any event.</p>	<p>(A call comes in on an outside line.)</p> <p>[Non-handsfree] To answer incoming call, lift the handset and press the appropriate line key.</p> <p>[Handsfree] To answer incoming call, press the appropriate line key.</p>	<p>Corresponding line indicator FLASHES slowly, and ringing is heard.</p> <p>Ringing stops, corresponding line indicator WINKS slowly, and you are connected to the outside caller.</p> <p>Ringing stops, corresponding line indicator WINKS slowly, and you are connected to the outside caller.</p>
<p><b>Intercom Call Pickup</b></p> <p>Unless prevented from doing so because of your line group type (see Line Group Type feature), you can answer intercom pages and internal calls intended for other stations from your own Set.</p>	<p>[Non-handsfree] Lift handset, and press <b>Intercom</b>.</p> <p>[Handsfree] Press <b>Intercom</b>.</p> <p>Dial *3.</p> <p>Press station select key for paged or called station.</p>	<p>Continuous tone is heard, and <b>Intercom</b> indicator WINKS slowly.</p> <p>Continuous tone is heard, and <b>Intercom</b> indicator WINKS slowly.</p> <p>Tone stops.</p> <p>You are connected to paging or calling party.</p>
<p><b>Intercom Paging (to a single station)</b></p> <p>Also, see <b>Internal Calling</b>.</p>	<p><i>To issue page to individual station:</i></p> <p>[Non-handsfree] Lift handset, press <b>Intercom</b> and desired station select key.</p> <p>[Handsfree] Press desired station select key.</p> <p>Make your announcement.</p> <p><i>To answer individual page:</i></p> <p>[Non-handsfree] Lift handset.</p> <p>[Handsfree] Speak in direction of Set.</p>	<p>...</p> <p>At both stations, single tone is heard, and <b>Intercom</b> indicator WINKS slowly.</p> <p>At both stations, single tone is heard, and <b>Intercom</b> indicator WINKS slowly.</p> <p>Announcement is heard at paged station.</p> <p>...</p> <p>You are connected to paging party.</p> <p>You are connected to paging party.</p>

<b>Function</b>	<b>User Action</b>	<b>Set/System Response</b>
<p><b>Intercom Paging</b> (to all stations — also known as All Page)</p> <p>Also, see <b>Zone Paging</b>.</p>	<p><i>To issue page to all stations:</i></p> <p>[Non-handsfree] Lift handset, press <b>Intercom</b> and <i>your own</i> station select key.</p> <p>[Handsfree] Press <i>your own</i> station select key.</p> <p>Make your announcement.</p> <p><i>To answer All Page from your station:</i></p> <p>[Non-handsfree] Lift handset, press <b>Intercom</b>, and dial *1.</p> <p>[Handsfree] Dial *1.</p>	<p>...</p> <p>At all stations, double tone is heard, and <b>Intercom</b> indicator WINKS slowly.</p> <p>At all stations, double tone is heard, and <b>Intercom</b> indicator WINKS slowly.</p> <p>Announcement is heard at all stations.</p> <p>...</p> <p>You are connected to paging party.</p> <p>You are connected to paging party.</p>
<p><b>Internal Calling</b></p> <p>Also, see <b>Intercom Paging</b> (to a single station)</p>	<p><i>To issue page to individual station:</i></p> <p>[Non-handsfree] Lift handset, and press <b>Intercom</b>.</p> <p>[Handsfree] Press <b>Intercom</b>.</p> <p>Dial 2-digit number (10-15) of desired station.</p> <p><i>To answer internal call:</i></p> <p>[Non-handsfree] Lift handset.</p> <p>[Handsfree] Press <b>Speaker</b>.</p>	<p>...</p> <p>Continuous tone is heard, and <b>Intercom</b> indicator WINKS slowly.</p> <p>Continuous tone is heard, and <b>Intercom</b> indicator WINKS slowly.</p> <p>Tones stops, and repeating ringing is heard at called station.</p> <p>...</p> <p>Ringing stops, and you are connected to calling party.</p> <p>Ringing stops, and you are connected to calling party.</p>
<p><b>Last Number Redial</b></p> <p>If auto hold is activated (see Auto Hold feature), <b>Speed</b> must be pressed <i>before Redial</i> — otherwise, outside line will be placed on hold, and <b>Redial</b> will have no effect.</p>	<p>[Non-handsfree] Lift handset, and press desired line key.</p> <p>[Handsfree] Press * or desired line key.</p> <p>Press <b>Redial</b> (if auto hold is activated, press <b>Speed</b> first).</p>	<p>Dial tone is heard, and line indicator WINKS slowly.</p> <p>Dial tone is heard, and line indicator WINKS slowly.</p> <p>Last number dialed from your station is redialed.</p>

Function	User Action	Set/System Response
<p>Night Transfer (must be activated from station 10)</p> <p>Stations selected by the Night Transfer Ringing feature will — when activated as described in this procedure — ring during all incoming calls, regardless of the ringing pattern determined by the Ringing Assignment feature.</p> <p>If the external loud bell is programmed for night bell (or day and night bell) by the Loud Bell feature, it too will ring during any incoming call when night transfer is activated.</p>	<p><i>To activate night transfer ringing:</i></p> <p>At station 10, press <b>Intercom</b>.</p> <p>At station 10, dial *9.</p> <p><i>To cancel night transfer ringing:</i></p> <p>At station 10, press <b>Intercom</b>.</p> <p>At station 10, dial *8.</p>	<p>...</p> <p>Continuous tone is heard, and <b>Intercom</b> indicator WINKS slowly.</p> <p>Tone stops, and preselected stations will ring during incoming calls.</p> <p>...</p> <p>Continuous tone is heard, and <b>Intercom</b> indicator WINKS slowly.</p> <p>Tone stops, and stations revert to their normal ringing assignments.</p>
<p><b>OPX Procedures</b></p> <p>The OPX Unit allows a 2-wire device (such as an answering machine, a modem, or a standard set) to be connected to the Panther 306 Electronic Key Telephone Set. The OPX Unit also allows such devices to be located up to 2 miles away from the KSU over a user-installed circuit. Finally, the OPX Unit also allows such devices to be located at any distance from the KSU through an outside CO line.</p> <p>When redialing last number dialed or when dialing common speed call numbers, the last outside line used by your set is selected. If this line is unavailable, the next available, lowest-numbered line is used instead.</p>	<p>1. To make an internal call:</p> <ul style="list-style-type: none"> <li>• Lift handset on standard 2-wire set.</li> <li>• Dial 2-digit (10-15) number of desired station.</li> </ul> <p>2. To make an outside call:</p> <ul style="list-style-type: none"> <li>• Lift handset.</li> <li>• Press * and dial 2-digit (01-03) number of desired outside line.</li> <li>• Within 10 seconds, start dialing desired outside party's telephone number.</li> </ul> <p>3. To redial last number dialed:</p> <ul style="list-style-type: none"> <li>• Lift handset.</li> <li>• Dial #0.</li> </ul>	<p>...</p> <ul style="list-style-type: none"> <li>• Continuous tone is heard.</li> <li>• Call is made to desired station: if invalid or unassigned number was dialed, broken tone is heard; if desired station is busy, slow broken tone is heard.</li> </ul> <p>...</p> <ul style="list-style-type: none"> <li>• Continuous tone is heard.</li> <li>• Outside dial tone is heard.</li> <li>• Call is made to desired outside party.</li> </ul> <p>...</p> <ul style="list-style-type: none"> <li>• Continuous tone is heard.</li> <li>• Last number dialed at your set is redialed.</li> </ul>

[continued on next page]

Function	User Action	Set/System Response
<p><b>OPX Procedures</b></p> <p>[continued from previous page]</p> <p>If optional external music source is connected, outside party will hear background music while on hold.</p> <p>If so programmed, Hold Recall Time feature sounds reminder signal <i>after</i> call has been on hold for program-selected period*: when handset is in cradle, OPX reminder signal is 4 bursts of ringing, repeated every 10 seconds; when handset is lifted, OPX reminder signal is double beep, repeated every 60 seconds.</p> <p>Many OPX procedures — such as placing calls on hold or retrieving calls you placed on hold — involve the hookswitch. Holding the hookswitch down too long will result in an undesired termination of a call; holding it down for too short a time will not produced the desired (or any other) effect. Practice using the hookswitch so that you can hold it down for the proper length of time.</p> <p>[continued on next page]</p>	<p>4. To place an outside call on hold:</p> <ul style="list-style-type: none"> <li>• Press hookswitch temporarily. You may now hang up.</li> </ul> <p>5. To retrieve an outside call that you placed on hold — <i>before</i> reminder signal occurs:</p> <ul style="list-style-type: none"> <li>• If handset is in its cradle, lift it up; press hookswitch temporarily.</li> <li>• If handset is already lifted, press hookswitch temporarily.</li> </ul> <p>6. To retrieve an outside call that you placed on hold — <i>after</i> reminder signal occurs:</p> <ul style="list-style-type: none"> <li>• If handset is in its cradle, lift it up.</li> <li>• If your are on an outside call:               <ul style="list-style-type: none"> <li>•• Press hookswitch temporarily and hang up.</li> <li>•• Lift handset in response to ringing of reminder signal.</li> </ul> </li> <li>• If your are on an inside call (or an outside call you have nearly completed):               <ul style="list-style-type: none"> <li>•• Hang up handset.</li> <li>•• Lift handset in response to ringing of reminder signal.</li> </ul> </li> </ul>	<p>...</p> <ul style="list-style-type: none"> <li>• Broken tone is heard, followed by continuous tone; outside party is placed on hold.</li> </ul> <p>...</p> <ul style="list-style-type: none"> <li>• Connection with outside party placed on hold is re-established.</li> <li>• Connection with outside party placed on hold is re-established; existing outside party, if any, is placed on hold.</li> </ul> <p>...</p> <ul style="list-style-type: none"> <li>• Connection with calling party placed is established.</li> <li>• ...</li> <li>•• Current outside party is placed on hold, and your set rings.</li> <li>•• Connection with previous party placed on hold is re-established.</li> </ul> <p>• ...</p> <ul style="list-style-type: none"> <li>•• Connection with current party is terminated, and your set rings.</li> <li>•• Connection with previous party placed on hold is re-established.</li> </ul>

\* Options include no reminder — or reminder after 1.5 minutes, 3 minutes, or 3 minutes with call release after 5 minutes.

# Operating Instructions

## Technical Service Manual

Function	User Action	Set/System Response
<p>OPX Procedures</p> <p>[continued from previous page]</p> <p>As is the case with Panther Sets, outside lines ring on your OPX-connected set in accordance with Ringing Assignment feature programming. If more than one such outside line has an incoming call for your set, a call on the last used outside line will be answered first — or on the lowest-numbered outside line.</p> <p>To place both outside parties on an external conference call on hold, press your hookswitch temporarily. To retrieve <i>both</i> parties on hold, press your hookswitch again. (You cannot go directly back to 2-party call from a 3-party conference call.)</p> <p>During an attempt to form any 3-party conference call, if the third party does not answer, simply hang up, lift handset, and press hookswitch to retrieve the original party placed on hold.</p> <p>[continued on next page]</p>	<p>7. To answer any call while handset is in cradle:</p> <ul style="list-style-type: none"> <li>• Lift handset.</li> </ul> <p>8. To answer an incoming call while busy on another call:</p> <ul style="list-style-type: none"> <li>• Press hookswitch temporarily and hang up (alternatively, you can terminate your current call instead of placing it on hold by simply hanging up).</li> <li>• Lift handset in response to ringing.</li> </ul> <p>9. To form an external conference call:</p> <ul style="list-style-type: none"> <li>• While on outside call, press hookswitch temporarily.</li> <li>• Press * and dial 2-digit (01-03) number of desired outside line.</li> <li>• Dial desired outside third party's telephone number.</li> <li>• When third party answers, press hookswitch temporarily.</li> </ul> <p>10. To form an internal conference call:</p> <ul style="list-style-type: none"> <li>• While on inside call, press hookswitch temporarily.</li> <li>• Dial 2-digit (10-15) number of desired station.</li> <li>• When third party answers, press hookswitch temporarily.</li> </ul>	<p>...</p> <ul style="list-style-type: none"> <li>• You are connected to calling party.</li> </ul> <p>Double beep is heard through handset.</p> <ul style="list-style-type: none"> <li>• If hookswitch pressed, current outside party is placed on hold; your set rings.</li> <li>• Connection with calling party is established.</li> </ul> <p>...</p> <ul style="list-style-type: none"> <li>• Current outside party is placed on hold; continuous tone is heard.</li> <li>• Outside dial tone is heard; if desired line is unavailable, broken tone is heard.</li> <li>• Call is made to desired outside third party.</li> <li>• 3-party external conference call is established.</li> </ul> <p>...</p> <ul style="list-style-type: none"> <li>• Current inside party is placed on hold; continuous tone is heard.</li> <li>• Call is made to desired station: if invalid or unassigned number is dialed, broken tone is heard; if dialed station is busy, slow broken tone is heard.</li> <li>• 3-party internal conference call is established.</li> </ul>

Function	User Action	Set/System Response
<p><b>OPX Procedures</b></p> <p>[continued from previous page]</p> <p>Just like with regular Panther Sets, Do Not Disturb prevents all calls from ringing at your station. Anyone trying to call will receive broken tone. When you pick up your handset, you will hear a broken tone followed by a continuous tone while Do Not Disturb is activated at your set.</p> <p>[continued on next page]</p>	<p>11. To form a mixed conference call:</p> <ul style="list-style-type: none"> <li>• While on outside call, press hook-switch temporarily.</li> <li>• Dial 2-digit (10-15) number of desired station.</li> <li>• When third party answers, press hookswitch temporarily.</li> </ul> <p>12. To activate Do Not Disturb:</p> <ul style="list-style-type: none"> <li>• Lift handset.</li> <li>• Dial #1.</li> </ul> <p>13. To cancel Do Not Disturb:</p> <ul style="list-style-type: none"> <li>• Lift handset.</li> <li>• Dial #1.</li> </ul> <p>14. To make a zone page:</p> <ul style="list-style-type: none"> <li>• Lift handset.</li> <li>• Dial # plus desired 2-digit zone number (51 to 56 — or 50 for all zones).</li> <li>• Make your announcement.</li> </ul>	<p>...</p> <ul style="list-style-type: none"> <li>• Current outside party is placed on hold; continuous tone is heard.</li> <li>• Call is made to desired station: if invalid on unassigned number is dialed, broken tone is heard; if dialed station is busy, slow broken tone is heard.</li> <li>• 3-party mixed conference call is established.</li> </ul> <p>...</p> <ul style="list-style-type: none"> <li>• Continuous tone is heard.</li> <li>• Tone stops, and Do Not Disturb is activated.</li> </ul> <p>...</p> <ul style="list-style-type: none"> <li>• Continuous tone is heard.</li> <li>• Tone stops, and Do Not Disturb is cancelled.</li> </ul> <p>...</p> <ul style="list-style-type: none"> <li>• Continuous tone is heard.</li> <li>• At both calling and called stations, double tone is heard (triple tone if all zones paged).</li> <li>• Announcement is heard by all called stations.</li> </ul>

Function	User Action	Set/System Response
<p>OPX Procedures</p> <p>[continued from previous page]</p> <p>Busy override has no effect on a Set that has activated Do Not Disturb.</p> <p>In any event, responder may ignore busy override signals.</p> <p>[end of OPX procedures]</p>	<p>15. To activate busy override:</p> <ul style="list-style-type: none"> <li>• When busy station (slow broken tone) is encountered, press #.</li> </ul> <p>16. To respond to busy override signal:</p> <ul style="list-style-type: none"> <li>• Press hookswitch temporarily.</li> <li>• When finished with busy override party, hang up, lift handset, and press hookswitch temporarily.</li> </ul> <p>17. To retrieve an outside call that <i>another station</i> placed on hold:</p> <ul style="list-style-type: none"> <li>• After receiving notification from other station — but without hanging up handset — press hookswitch <i>for at least 1 second</i>, then release it.</li> <li>• Dial ** and the indicated line number (01 to 03).</li> </ul>	<p>...</p> <ul style="list-style-type: none"> <li>• Busy station hears three ringing bursts every time you press #.</li> </ul> <p>While on a call, three beeps are heard (and repeat every 60 seconds that current party remains on line).</p> <ul style="list-style-type: none"> <li>• Current party is placed on hold, and you are connected to party activating busy override signal.</li> <li>• Connection with party on hold is re-established.</li> </ul> <p>Typically, the other station calls you and lets you know which outside line the call is on. — and then hangs up.</p> <ul style="list-style-type: none"> <li>• Dial tone is heard.</li> <li>• Dial tone stops, and you are connected with the party on hold.</li> </ul> <p>(To put this party on hold again, press hookswitch only temporarily; subsequently, to retrieve this party form the second hold, press hookswitch temporarily again.)</p>
<p>Outgoing Call</p> <p>In handsfree operation, pressing * (as first entry in telephone number sequence) automatically selects last outside line used at station making call.</p>	<p>[Non-handsfree] Lift handset, and press desired line key.</p> <p>[Handsfree] Press * or desired line key.</p> <p>Dial desired outside number.</p>	<p>Dial tone is heard, and selected line indicator WINKS slowly.</p> <p>Dial tone is heard, and selected line indicator WINKS slowly.</p> <p>Call is made to desired outside party.</p>



Function	User Action	Set/System Response
<p><b>Private Speed Calls</b></p> <p>If auto hold is activated (see Auto Hold feature), <b>Speed</b> must be pressed <i>before</i> pressing desired speed dial key — otherwise, outside line will be placed on hold, and speed call key will have no effect.</p>	<p>[Non-handsfree] Lift handset, and press desired line key.</p> <p>[Handsfree] Press * or desired line key.</p> <p>For first 5 private speed call numbers, press desired speed call key (11 to 15) — press <b>Speed</b> first if auto hold is activated; for last 6 private speed call numbers dial desired speed call code (05 to 10).</p>	<p>Dial tone is heard, and selected line indicator WINKS slowly.</p> <p>Dial tone is heard, and selected line indicator WINKS slowly.</p> <p>Desired number is dialed automatically.</p>
<p><b>Room Monitoring</b></p> <p>For this procedure to work properly, the monitoring Set must have its microphone turned off, and the monitored Set must have its microphone turned on.</p>	<p>At monitoring station, press station select key for station to be monitored.</p> <p>To cancel room monitoring, press <b>Speaker</b> at monitoring station.</p>	<p>At both sets, single tone is heard, and <b>Intercom</b> indicator WINKS slowly; sounds made in vicinity of monitored station are heard over monitoring station's speaker.</p> <p>Room monitoring is cancelled, and <b>Intercom</b> indicator goes OFF at both stations.</p>
<p><b>Zone Paging (to a specific zone)</b></p> <p>Also, see <b>Intercom Paging (to all stations)</b></p>	<p>[Non-handsfree] Lift handset, and press <b>Intercom</b>.</p> <p>[Handsfree] Press <b>Intercom</b></p> <p>Dial the desired zone number (51 to 56).</p> <p>Make your announcement.</p>	<p>Continuous tone is heard, and <b>Intercom</b> indicator WINKS slowly.</p> <p>Continuous tone is heard, and <b>Intercom</b> indicator WINKS slowly.</p> <p>Triple tone is heard at calling and at all called stations .</p> <p>Announcement is heard at all called stations.</p>

# Operating Instructions

Technical  
Service  
Manual

Function	User Action	Set/System Response
<b>Zone Paging</b> (to all zones)	<i>To issue an all zone page:</i>	...
Also, see <b>Intercom Paging</b> (to all stations)	Lift handset, and press <b>Intercom</b> — or <i>your own</i> station select key.	Continuous tone is heard, and <b>Intercom</b> indicator WINKS slowly.
	Dial <b>50</b> .	Double tone is heard at calling and at all called stations .
	Make your announcement.	Announcement is heard at all called stations.
	<i>To respond to an all zone page:</i>	...
	[Non-handsfree] Lift handset, and dial *1.	You are connected to paging party.
[Handsfree] Dial *1.	You are connected to paging party.	

<b>Problem</b>	<b>Probable Cause</b>	<b>Probable Solution</b>
No dial tone, but indicators go ON, and intercom tone is heard at your Set	Reversed tip and ring on intercom (data) pair	Correct station wiring (refer to Station Wiring Table on page D-3).
When <b>Intercom</b> pressed, continuous tone not heard and <b>Intercom</b> indicator stays OFF	<ul style="list-style-type: none"> <li>a. Incorrect station wiring</li> <li>b. Improperly connected modular cord</li> <li>c. MDF connection</li> <li>d. Static discharge</li> <li>e. Loss of power to KSU</li> </ul>	<ul style="list-style-type: none"> <li>a. Make sure station wiring is correct (refer to Station Wiring Table on page D-3); check for opens, shorts, wire reversals, and incorrect color code matches.</li> <li>b. Make sure 4-wire modular cord is plugged securely into Set and into station wiring jack (6-wire cord is used at stations with external amplifier — see page D-8).</li> <li>c. Check wiring of 66-block; again, refer to Station Wiring Table on page D-3.</li> <li>d. Disconnect modular cord from Set and re-connect (this action resets the Set); if problem persists, remove and re-apply power to KSU (this action resets the KSU).</li> <li>e. Verify that KSU is connected to unswitched outlet; check that the ground wire is still connected to true earth ground; make sure breaker for outlet is not tripped; and, if using a surge protector, make sure that the surge protector is operational.</li> </ul>
At all Sets, when line key is pressed, the indicator lights but no dial tone is heard.	Faulty Central Office line connection to the KSU.	Make sure 4-conductor modular cord between RJ-14 jack (where incoming line terminates) and KSU is good and is properly installed. (If you are using Power Fail Transfer Units, check all connections between incoming lines, Power Fail Transfer Units, and KSU — refer to page D-7 and see the diagram on page E-4.) If problem persists, notify your local telephone company.

# Trouble-shooting

Technical  
Service  
Manual

Problem	Probable Cause	Probable Solution
KSU does not retain feature programming	KSU BATTERY switch is OFF	Set KSU BATTERY switch to ON; re-program system as necessary.
Outside calls cannot be made	<p>a. Error in tone/rotary programming</p> <p>b. Incorrectly programmed call restrictions</p>	<p>a. Verify that the Tone or Pulse and Telephone or PBX features (program code 5XX0) are properly programmed (see Section F).</p> <p>b. Verify correct programming for the Line Group Type feature (program code 0011), Digits-to-Deny feature (program code 0051), Call Restrictions feature (program code 1YY1), Line Group Assignment feature (3YY0), Line Grouping feature (program code 6ZZ0), and Flexible Call Restrictions feature (program codes 7000-7900), as appropriate (see Section F).</p>
Line indicator FLASHES slowly during an incoming call, but no ringing is heard	Incorrectly programmed Ringing Assignment feature (program code 2YY0)	For your Set to ring, it must be programmed to do so by the Ringing Assignment feature — for each incoming line you wish to ring at your Set (see Section F).
Background music and on-hold music not heard on any set	<p>a. Incorrect connector on cable from music source</p> <p>b. Malfunctioning music source</p>	<p>a. Make sure that jack is 1-8-inch phono mini-jack — not stereo or attenuator.</p> <p>b. Make sure music source is plugged in, turned on, and operating properly. Refer to manual supplied with music source equipment or call music source equipment manufacturer's customer service.</p>

<b>Problem</b>	<b>Probable Cause</b>	<b>Probable Solution</b>
Neither Door Module is operational	<ul style="list-style-type: none"> <li>a. Wiring between Door Answer Unit and KSU</li> <li>b. KSU not operating properly</li> <li>c. Defective Door Answer Unit</li> </ul>	<ul style="list-style-type: none"> <li>a. Check continuity of 6-conductor cord between DA connector on Door Answer Unit and DOOR connector on KSU.</li> <li>b. Press RESET button on KSU.</li> <li>c. Replace Door Answer Unit.</li> </ul>
Individual Door Module not operating properly	<ul style="list-style-type: none"> <li>a. Wiring between Door Module and Door Answer Unit</li> <li>b. Defective Door Module</li> <li>c. Defective Door Answer Unit</li> </ul>	<ul style="list-style-type: none"> <li>a. Check continuity of 2-wire cable between Door Module and Door Answer Unit.</li> <li>b. Replace Door Module.</li> <li>c. Replace Door Answer Unit.</li> </ul>
2-wire set or other device connected to OPX unit not working properly	<ul style="list-style-type: none"> <li>a. Station wiring defective or KSU working improperly</li> <li>b. Defective OPX unit</li> <li>c. Defective 2-wire device</li> </ul>	<ul style="list-style-type: none"> <li>a. Temporarily install Panther 306 Set at OPX unit station jack: if installed Set doesn't work properly, check station wiring and/or reset KSU. Re-install OPX unit at station jack once trouble is cleared.</li> <li>b. Replace OPX unit.</li> <li>c. Make sure 2-wire device is plugged in, turned on, and operating properly. Refer to manual supplied with 2-wire device or call 2-wire device manufacturer's customer service.</li> </ul>